

Resilient Product Guide

2019

For more than 130 years, Tarkett has been at the foundation of **creating more beautiful spaces**, unlocking the **infinite possibilities** that happen when **we come together**.

We believe in the power of collaboration, going the extra mile and investing in the future. **Please join us.**

Welcome to
Tarkett.



The power of collaboration.

CREATING TOGETHER

Tarkett believes deeply in the value of collaboration, in bringing together different voices and ideas to create something worth more than the sum of its parts. Within our walls, we're committed to fostering a diverse work environment that encompasses and nurtures people from all backgrounds, ages, races, ethnic groups, and lifestyles. Outside our walls, we've been co-creating with our customers and prominent designers around the globe to create flooring solutions that inspire. When you or your customers ask if something is possible, Tarkett's response is almost always a resounding Yes. If you can imagine it, we'll work to create it.



We understand the constant balancing act inherent in every project. The long, often competing list of demands that can force difficult trade-offs. To help alleviate the tension, we've developed a uniquely comprehensive portfolio of soft and resilient floorcoverings—the **Tarkett Solution SPECTrum™**—to help you specify flooring products with total confidence.

The Tarkett Solution SPECTrum™ helps you expertly recommend a flooring platform for the specific needs of every space and every budget. And our full palette of colors, patterns, and textures is coordinated to work together visually across platforms. So the endless balance of function, safety, and durability is always done on budget, in style, without compromise.

In short, no one covers you better.

Spec with confidence.



RUBBER

Investing in
the future.
Doing good
together.



At Tarkett, we believe that together, we can make a positive impact on people and the planet. That's why we're Doing Good—Together, connecting our sustainability efforts with what our customers value and our world needs. It's an active, living commitment to create a future where people and the planet prosper in balance.

Doing Good—Together means Designing for Life. A life where we respect natural resources and good materials contribute to people-friendly spaces. It means Closing the Loop, building a circular economy in which resources are responsibly stewarded, recycled and continually re-used. And Doing Good—Together means Driving Collaboration, an open invitation to our customers, our partners, and our industry to join us in creating a healthy, beautiful and sustainable world.



DESIGNING FOR LIFE

Developing products based on Cradle to Cradle® principles that contribute to people-friendly spaces and respect the planet's natural capital.

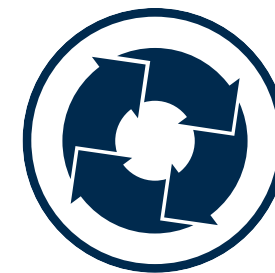

CLOSING THE LOOP

Building a circular economy inclusive of programs and business models that encourage take back, reuse, recycling and elimination of waste.



DRIVING COLLABORATION

Inviting others to join us in Doing Good through education, collaboration, transparency and communication.



A global impact.

Doing Good—Together is inspired by the world’s most ambitious sustainability goals and organizations. From our membership in the World Economic Forum to our participation in the UN Global Compact and our alignment with the UN Sustainable Development Goals, we’re committed to big ideals and positive action, working for the health of our products, our world, and a good future for all.



Thank you for helping us make real progress on a global scale.

We are the only North American flooring manufacturer to offer both commercial and residential products that are certified asthma and allergy friendly by the Asthma & Allergy Foundation of America.

We have the industry’s most ambitious inventory of Cradle to Cradle certified products covering multiple product categories, from resilient to soft surface, and from products to adhesives to maintenance. By 2020, 100% of Tarkett’s raw materials will be third-party assessed for health and planet impacts.

Our third-party verified Material Health Statements provide a true assessment of product ingredients and their long-term effects on people and the environment—versus the simple ingredient lists provided by other manufacturers.

By 2020, 75% of our raw materials will be recycled, rapidly renewable, or abundantly available in nature.

We’ve designed products to perform better in the long term with simple wet or dry buffing and neutral cleaning products—which means TVOC emissions are among

the lowest in the flooring industry and 10 to 100 times below the world’s strictest standard.

Our robust Take Back program is the oldest in the industry, building on a legacy of more than six decades of recycling.

We are collaborating on the Responsible Use of PVC Network to mobilize the industry so that together, we can improve the impact of our products on people and our planet.

Together, we’re making an impact.



Within the following pages, you'll find the work of artisans, designers, inventors and innovators. Creative solutions for every space that are both practical and beautiful—and fully designed by our skillful team in North America.

With remarkable expertise in resilient flooring, Johnsonite (part of the Tarkett family of brands) always has product designers, developers and managers in the field listening. By seeing and hearing our customers' needs firsthand, we're able to keep moving forward with innovative products that are responsive to real-life situations.

Our comprehensive portfolio reflects the performance you need, even for your most challenging projects. Moisture mitigation? We

have it with SureStart underlayment. Quick install? We have it with SureSet LVT. Custom colors for branding? Microtone Rubber Tile is one answer we'll provide to you. The list goes on and on.

Bonus—we provide color, texture and pattern coordination across product categories, helping you create seamless design aesthetics throughout a space.

We love helping you make great spaces. Let's do what we love. Together.

Chris Stulpin
Chief Creative Officer
Tarkett North America

TABLE OF CONTENTS

Thank you for considering Tarkett flooring products for your next design project. We look forward to working with you to create happier, healthier, more productive spaces.

<hr/> 12 Tarkett Support Services	<hr/> 87 Vinyl	<hr/> 171 Finishing Borders (Wall Base)
<hr/> 19 Rubber	<hr/> 131 Multi-Functional and Sports Flooring	<hr/> 185 Finishing Accessories
<hr/> 57 Linoleum	<hr/> 143 Specialty Applications	<hr/> 195 References
<hr/> 63 Luxury Vinyl Tile and Planks	<hr/> 161 Stairwell Management	

The Product Guide is our annual showcase piece for as many products as possible at the time of print. We are constantly updating our styles throughout the year, so please make sure you log onto tarkettna.com for the most up-to-date products.

Photos may not accurately depict color. Please order samples for exact product color.



With its state-of-the-art digital printing technology, Tarkett is able to recreate the look of everything from natural wood grains and stone effects to your favorite upholstery. Send us an image or physical sample of any material to create a fully customized flooring* or wall base that's uniquely your own.

Digital printing.



Imaginations custom floor design.

Add signature images to your flooring design, such as company logos, school mascots, government seals and more. These customized emblems let you use every plane of the interior space to create a unique experience and communicate a client's valuable brand message.



Millwork Masquerade

* Customized flooring coming Spring 2018





The world speaks in color and sometimes, you need to write your own language. Tarkett gives you options to achieve the unique character each space deserves. With LVT or Prima® rubber tile flooring, we can use anything—from a photograph to a fabric swatch—to create a customized floor color with just the right accent. We have no need for dye lots when working with rubber, so your signature color will be precise the first time, and with any reorders to come.



Millwork Masquerade

Color customization.

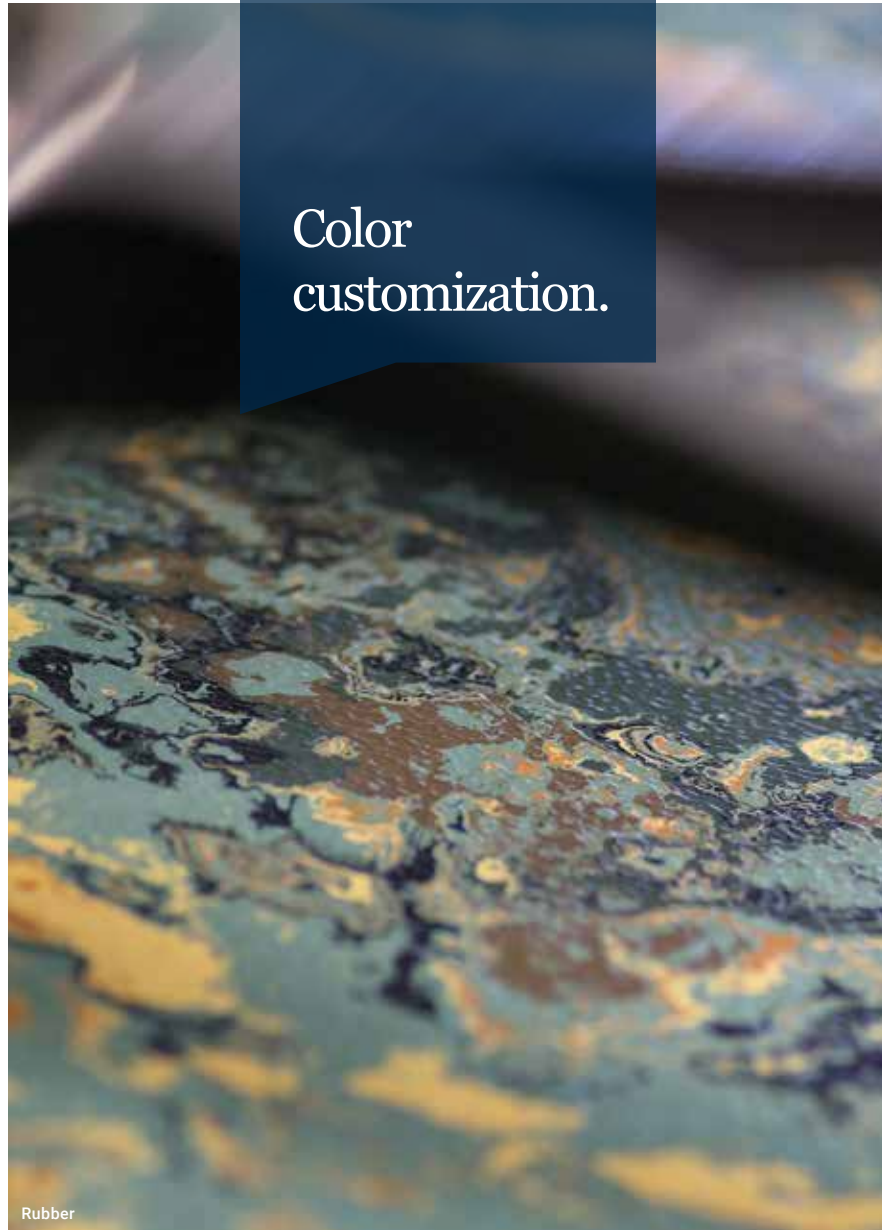

Rubber

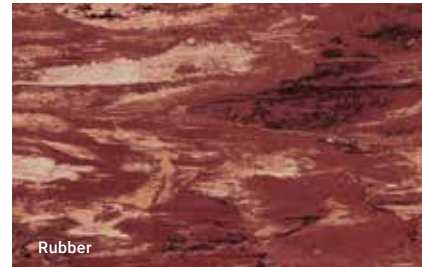

Rubber

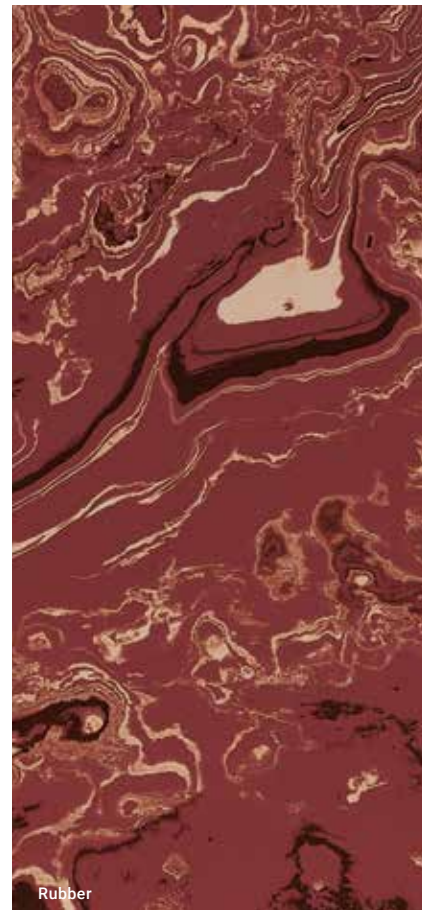

Rubber

Color foundations.

We may speak in color, but we're also fluent in neutrals. Color Foundations gives you six core neutral palettes that coordinate across our entire portfolio of floorcoverings, stair treads, wall base and accessories. As we update patterns and styles, we guarantee these core neutrals - warm beige, cool beige, warm grey, cool grey, black and white - will always be available, allowing spaces to be updated easily over time without losing the integrity of their original design.

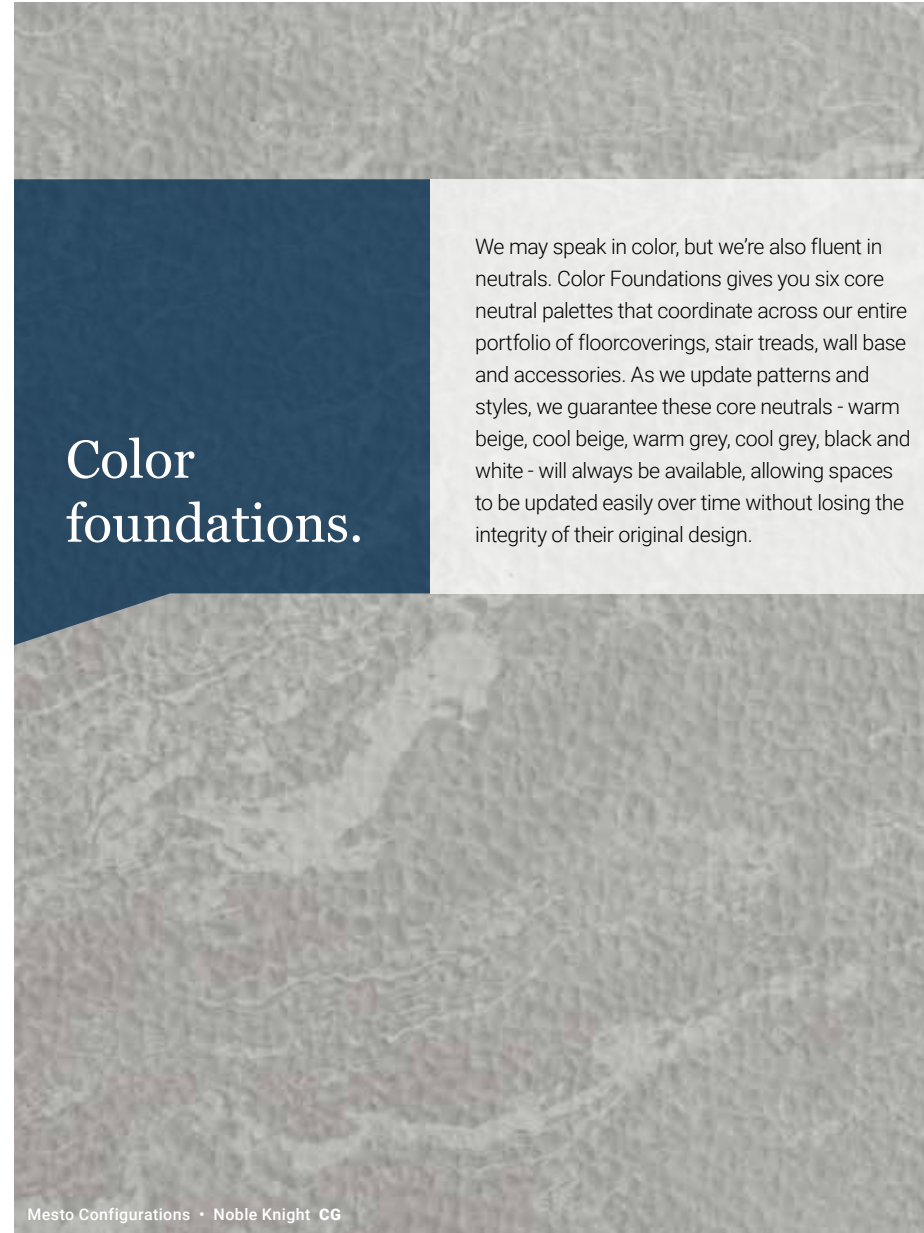

Mesto Configurations • Noble Knight CG



Harmonium xF² • Grizzled B



iQ Optima • Beluga W



Gemstone Glass • Crystal Clear CB



ID Freedom Abstracts • TexGrain Golden WB



Arja 2.0 • Ferris Wheel WG



Four hands always work faster than two. That's why we created the Designer on Demand program, offering free design support during and after normal business hours. One of our designers will follow your lead and vision to help you configure a space, order samples, and create everything from room scene renderings to floor plan designs—everything you need to pull designs together quickly and share them successfully with clients. It's a perfect cocreative relationship that saves you time.

Designer on Demand.



VINYL

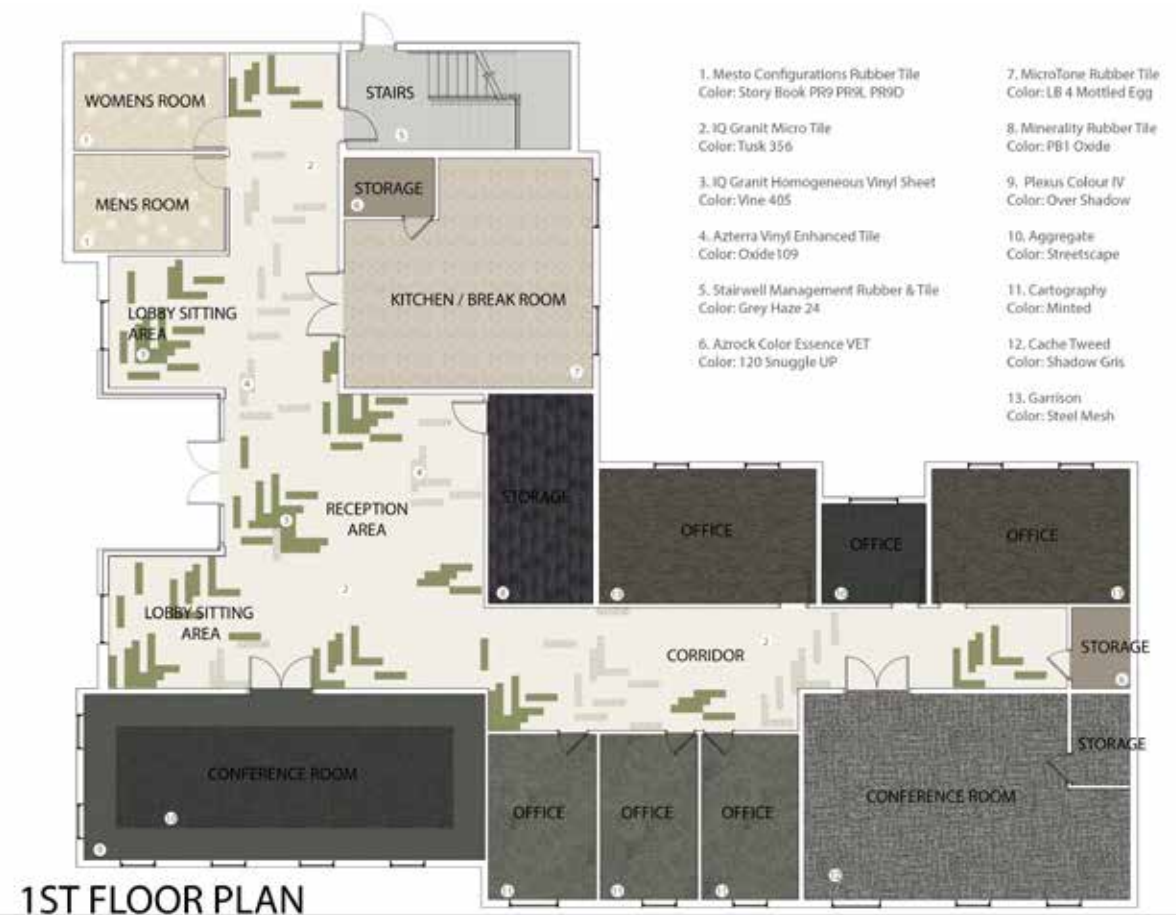



Rubber

Quietly supportive but able to command attention. Rubber doesn't just allow creative expression, but inspires it as well.

20
Surface Textures

34
Organics

48
Metallurgy™

24
Circulinity®

38
Minerality™

52
Eco-Naturals®
53 Eco-Shell™ with Cork Tile
54 CorkTones™

26
Pentagonals

42
Mesto Configurations™

30
MicroTone® Tile

46
Prima® Marbleized®
and Prima® Olio

Whatever you're looking to accomplish in a floor, rubber has a solution. Safe, comfortable, sustainable—and full of possibility—Tarkett's rubber flooring offers an unmatched variety of colors, patterns and textures, and no need for dye lots. With natural slip resistance, shock absorption, and comfortable acoustics, rubber just seems to check all the boxes.

All of these products are recyclable, and made in the U.S.A in ISO 9001 and ISO 14001 certified plant.



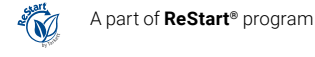
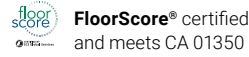

tile size = 24" x 24"
(610 mm x 610 mm nominal)

thickness = 1/8" (3.175mm)
and .080" (2mm)

Raised Round and
Raised Square textures
also available in .155"
(4 mm nominal) thickness

Let's talk tile.

Creating brilliant spaces starts with square one. Tiles, in this case. Choose bold colors that stand out, or neutral colors that blend in. Our flooring collection incorporates Color Foundations®, a system of guaranteed availability across 6 neutral palettes. Or, for the ultimate in design freedom, customize your own tiles in a Prima® Marbleized™, Prima® Olio® or Mesto Configurations™ design. Then, with performance features like natural slip resistance and shock-absorbing comfort, you'll arrive at solutions that look smart and act smart too.

SELECTING RUBBER TILE

1 Select a Pattern

2 Select a Texture

3 Select Colors

Choose from the industry's largest selection of standard colors or create your own.



SOLID

MICROTONE

PRIMA MARBELIZED

PRIMA OLIO

MESTO CONFIGURATIONS

MINERALITY

METALLURGY

BAMBOO

BRUSHED

CIRCULINITY® (5)

CONCRETE

CUBIS

DIAMOND

FLAGSTONE®

FORGED

HAMMERED

LEATHER

LINEN

RAISED ROUND

RAISED SQUARE

RICE PAPER

SMOOTH

WOODGRAIN

WOVEN

RUBBER TILE AND SHEET TEXTURE AVAILABILITY									
PRODUCT LINE	GAUGE	TILES						ROLLS	TEXTURES—SPECIAL ORDER AND STANDARD—(see chart below) (2)
		24" X 24"	12" X 12"	6" X 6"	6" X 24"	12" X 24"	6" X 48"		
Circulinity and Solid Colors	1/8"	STD	N/A	N/A	N/A	N/A	N/A	N/A	N/A
Defiant Oil and Grease-Resistant	1/8"	STD	STD	SO	SO	SO	SO	N/A	13
Eco-Naturals CorkTones	.080"	SO	SO	SO	SO	SO	SO	N/A	2-3-8-9-12
	1/8"	STD	SO	SO	SO	SO	SO	N/A	13
Eco-Naturals Eco Shell	.080"	SO	SO	SO	SO	SO	SO	N/A	2-3-8-9-12
	1/8"	STD	SO	SO	SO	SO	SO	N/A	13
Inertia Sports Flooring	1/4"	STD	N/A	N/A	N/A	SO	N/A	N/A	13
	3/8"	SO	N/A	N/A	N/A	SO	N/A	N/A	13
Mesto Configurations	.080"	STD	STD	STD	STD	STD	SO	N/A	2-3-8-9-12
	1/8"	SO	SO	SO	SO	SO	SO	N/A	13
Metallurgy	1/8"	STD	SO	SO	SO	SO	N/A	N/A	8
Microtone Speckled	.080"	STD	SO	SO	SO	SO	SO	N/A	2-3-8-9-12
	1/8"	SO	SO	SO	SO	SO	SO	N/A	13
Minerality	1/8"	SO	N/A	N/A	N/A	STD	STD	N/A	9
Organics	1/8"	STD	N/A	N/A	N/A	STD	SO	N/A	9
Pentagonals	1/8"	N/A	N/A	N/A	N/A	N/A	N/A	N/A	15
Prima Marbleized & Olio	1/8"	SO	STD	SO	SO	SO	SO	N/A	13-14
Replay Sport Flooring	1/4"	STD	N/A	N/A	N/A	N/A	N/A	STD	Replay
	3/8"	STD	N/A	N/A	N/A	N/A	N/A	STD	Replay
	1/2"	STD	N/A	N/A	N/A	N/A	N/A	SO	Replay
Solid Colors Rubber Tile	1/8"	STD	N/A	N/A	N/A	N/A	N/A	N/A	13-14
Triumph Sport Rubber*	3/8"	STD	N/A	N/A	N/A	SO	N/A	N/A	3-8-9-12

* Slidlock profile only available in Hammered Texture

(2) TEXTURES*		
1. Bamboo	7. Flagstone	13. Textures 1-11
2. Brushed	8. Hammered	14. Smooth for Accents
3. Concrete	9. Leather	15. Forged
4. Diamond	10. Raised Round	16. Linen
5. Cubis	11. Raised Square	17. Woodgrain
6. Fast Lane	12. Rice Paper	18. Woven

* Textures listed may be Standard or Special Order. See respective product section for standard offering.

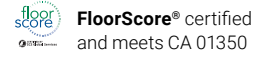

FloorScore® certified and meets CA 01350



Cradle to Cradle Bronze certified



A part of ReStart® program



Phthalate free

Talk texture.

Beyond pattern, texture provides another opportunity to make a statement. Choose from a dozen different stamped textures for added interest and slip resistance. All 16 standard textures are available in 142 solid colors from the color palettes, that let you coordinate finishing borders, accessories, stairwell management and more.

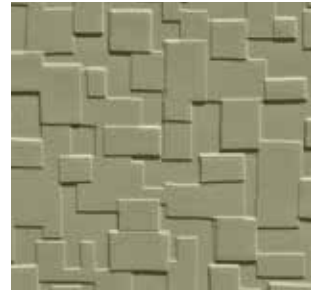

Cubis® (CRT)

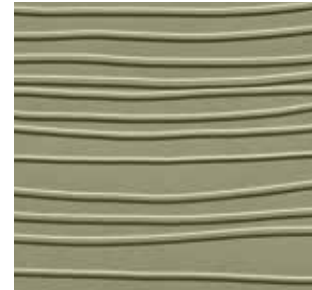

Bamboo® (BMRT)

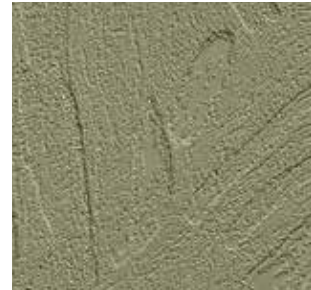

Flagstone (FRT)

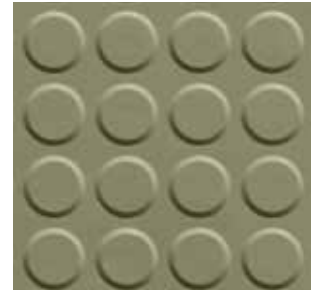

Raised Round® (RT-RD)



Brushed (BR)

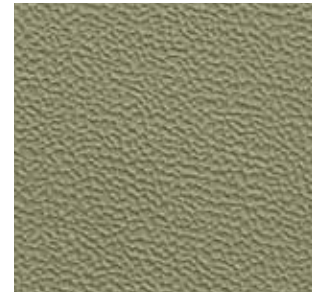

Hammered® (HRT)



Raised Square (RT-SQ)



Concrete (CO)



Leather (LR)



Rice Paper® (FRPA)



Smooth® (C orRET)

5 textures available in Circulinity®

(see page 24)



Forged (FG)



Linen (LE)



Woodgrain (WG)



Woven (WV)

With natural slip resistance, rubber flooring helps maximize safety in high-risk environments such as hospitals, nursing homes and daycare centers. It also helps absorb noise and reduce shock, which makes it very valuable to those on their feet all day.

Circulinity® textures shown on page 33.

† Available in coordinating rubber tread with integrated riser. See page 164.

Textures shown in one-half actual size.

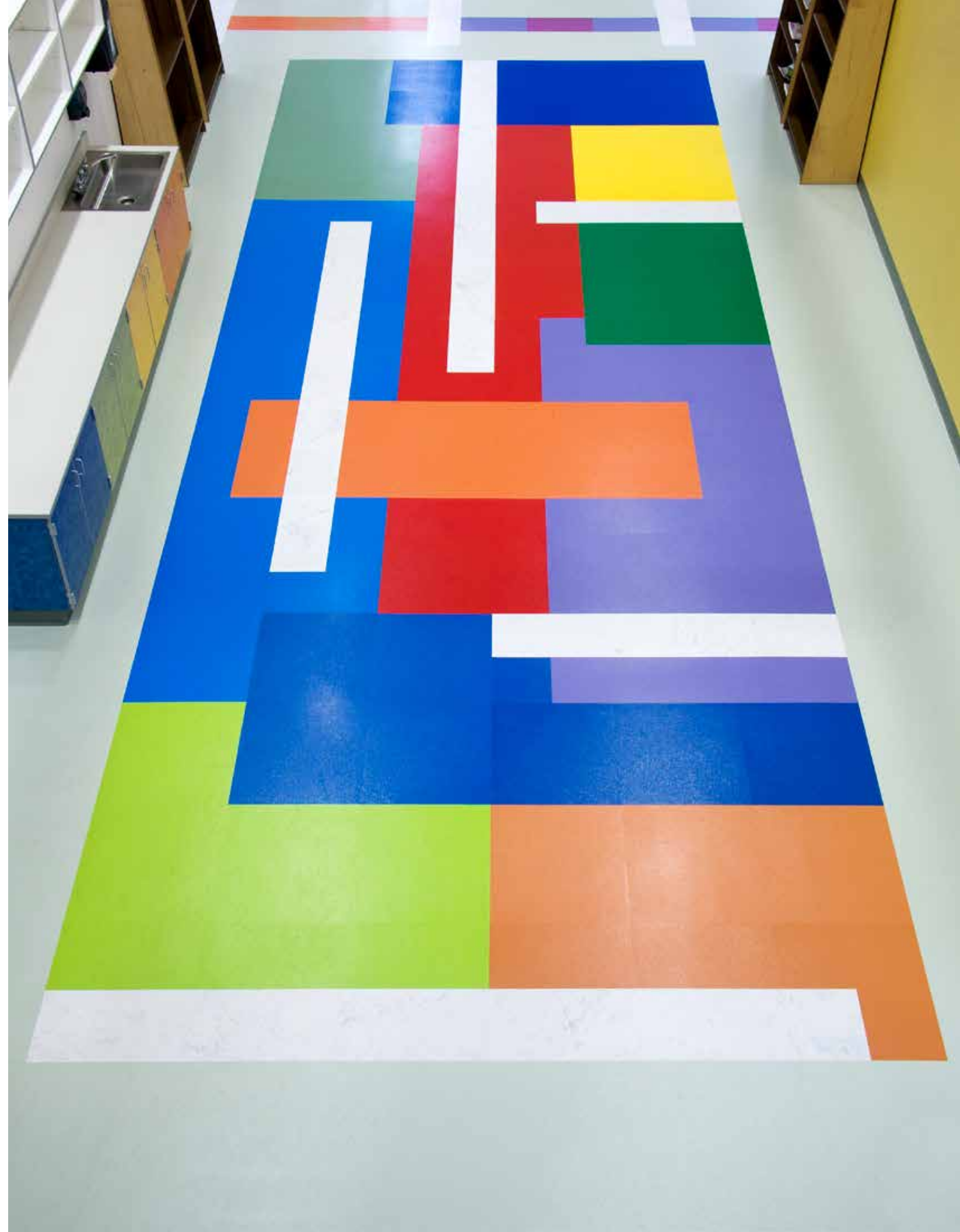



Circulinity®

RUBBER TILE

An updated Color Palette.

Reference the color guide in the back of the book to find our refreshed palette of standard colors, or speak to a Tarkett representative about your custom color needs. Circulinity is also available in coordinating FastLane stair treads. Stair treads are available with or without an integrated riser, both with and without striping for the visually impaired.



FastLane® (CFL)



Tricycle® (CTR)



Round-A-Bout® (CRB)



Tic-Tac-Toe® (CTT)



Effervescent® (CEF)

See page 34 for 40 Circulinity® favorites. A color palette developed especially to highlight the patterns and textures of this modern textile-inspired tile.

To view all circulinity options, please visit our website at tarkettna.com



ESSENTIALS & ACCENTS PALETTES

For available standard colors, reference Essentials & Accents palettes on the color guide in the back of the book. Custom colors available. Circulinity is also available in coordinating FastLane stair treads. Stair treads are available with or without an integrated riser, both with and without striping for the visually impaired.

Pentagonals

RUBBER TILE

Find your
angle.

For more than a century, mathematicians have been trying to solve one of the world's most intriguing geometric puzzles—searching for pentagonal shapes that “tile the plane,” or fill a surface without overlapping or leaving gaps. In all this time, only 15 such pentagons have been discovered—and now you can use three of them to create distinctive rubber floor designs. No one knows how many of the novel shapes exist—a mystery that adds wonder and intrigue to these artistic focal points.

PENTAGONALS

Style: Diamond Shape

Color: Black Pearl, Sterling

Platform: Rubber

 Tarkett

Custom Designs in 3 Easy Steps

Once you've chosen a shape for the space, our online visualizer will help you complete the design and tell you exactly how much material to order in each color.

CHOOSE A SHAPE.

Diamond comes as a single tile, while Monument and Shell each have a left and right to complete the pattern.

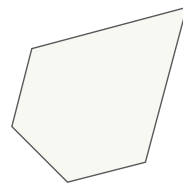

Diamond

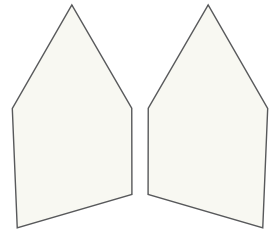

Monument

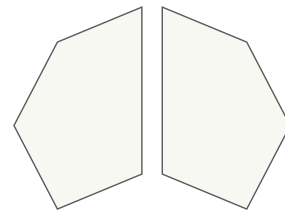

Shell

CREATE YOUR DESIGN.

To choose from patterns already designed, or to create your own design, visit the Pentagonals visualizer at

<https://pentagonals.tarkett.com>.

Download your finished layout and the corresponding Installation Guide as a reference for ordering and installation.

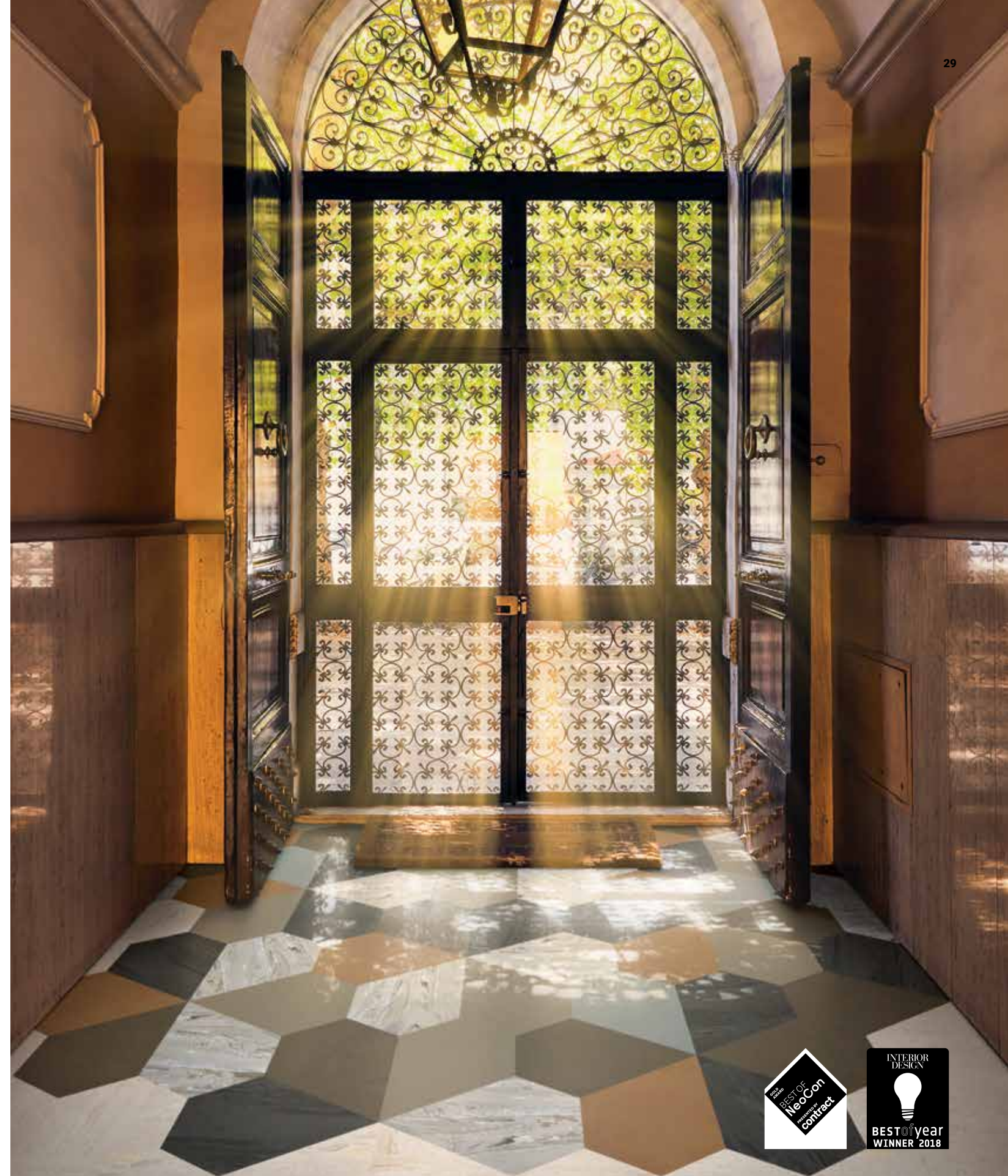



MicroTone®

RUBBER TILE

Expand your palette.

Select from 45 dynamic colorways to create a one-of-a-kind tapestry. Our Design-a-Space PRO Visualizer helps you customize your layout and then request a production sample to eliminate surprises. Matching borders, transitions and stair treads are also available to complete the space and simplify the entire process.



tile size = 24" x 24"
(610 mm x 610 mm nominal)
thickness = .080" (2 mm)

textures pg. 22
adhesives pg. 196
chip details pg. 200

We've identified Color Foundations neutrals in the following way: WB (warm beige), CB (cool beige), WG (warm grey), CG (cool grey), B (black), W (white).
* Suggested Tarkett colors for finishing borders (wall base). For our complete color offering, reference color guide in back.

SO = Special Order

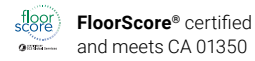

FloorScore® certified and meets CA 01350



A part of ReStart® program



Cradle to Cradle Bronze certified



Phthalate free

tile size = 24" x 24"
(610 mm x 610 mm nominal)
thickness = .080" (2 mm)

textures pg. 29
adhesives pg. 196
chip details pg.208

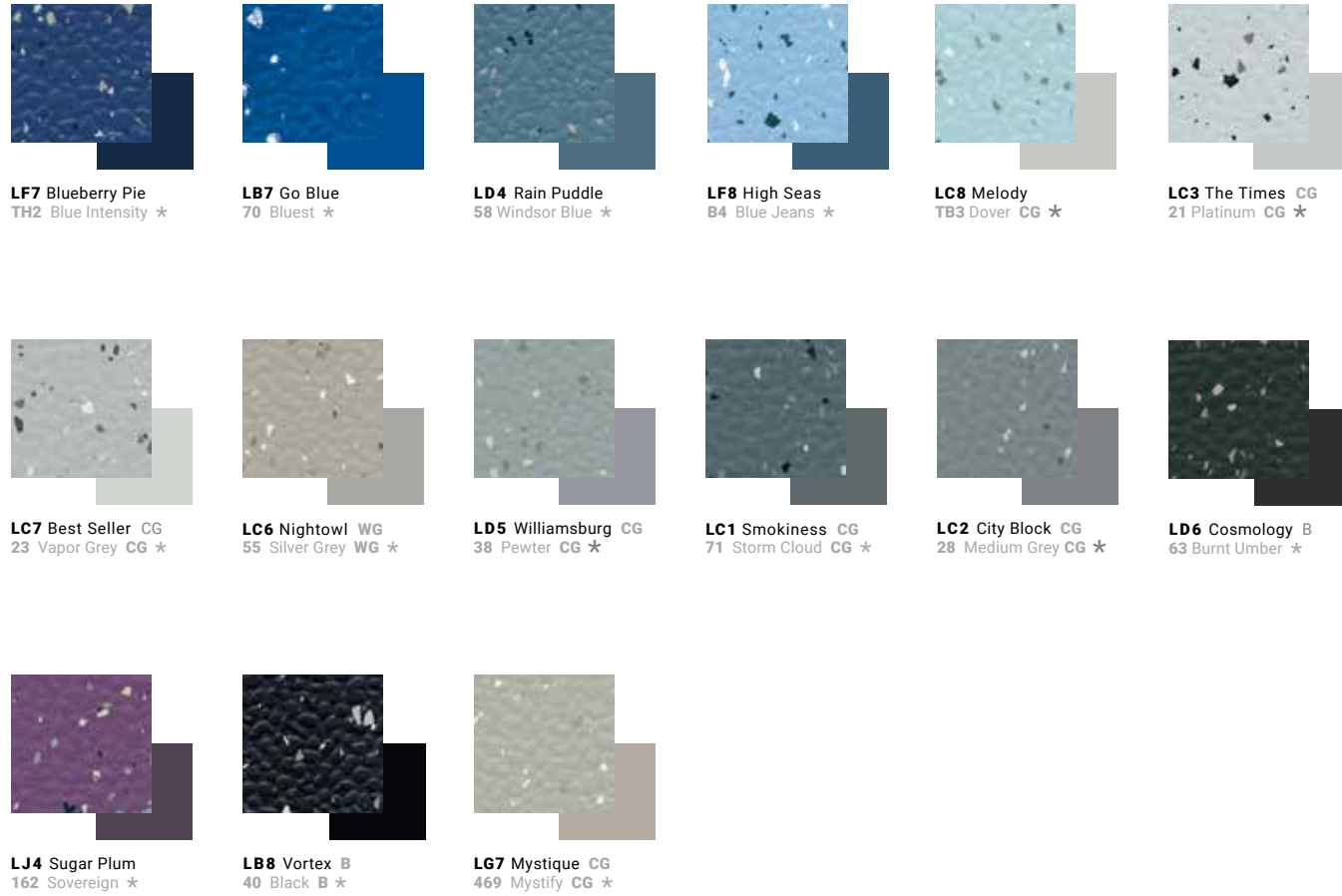

Experience underfoot comfort.

Our MicroTone® Speckled Rubber Tile offers underfoot comfort that makes it a great choice for many types of applications, including busy classrooms, office corridors, retail spaces and more. Naturally slip resistant, these rubber tiles help to reduce the risk of expensive slips and falls, and the resultant physical and financial costs that can ensue.

Color Foundations™ is our commitment to always have representation across 6 key neutral palettes.

We've identified Color Foundations neutrals in the following way: WB (warm beige), CB (cool beige), WG (warm grey), CG (cool grey), B (black), W (white).
* Suggested Tarkett colors for finishing borders (wall base). For our complete color offering, reference color guide in back.

SO = Special Order

Organics

RUBBER TILE AND PLANK

Naturally Beautiful.

With subtle color variations and more random patterning, this large-scale, free-flowing aesthetic lends an open, organic feel and updated appearance to any space—plus all the strength and comfort of traditional rubber flooring. While rubber is often reserved as a safe and comfortable solution for education and healthcare spaces, this stylish design is ready to greet guests and customers in the front of the house, from lobbies to conference rooms.

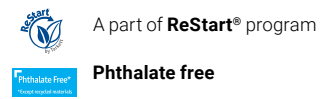
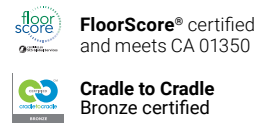

tile size = 12" x 24"
(305 mm x 610 mm nominal)
custom sizes available

plank size = 6" x 48"
(152 mm x 1.22 m nominal)
custom sizes available

thickness = 1/8" (3.175 mm)
adhesives pg. 196

Standard in leather texture.

ORGANICS



RH9 Crystallized W
TB3 Dover CG *



RH1 Marbra CG
23 Vapor Grey CG *



RH6 Emperador CB
31 Zephyr CB *



RH7 Brownstone CB
TA8 Welsch Castle CB *



RH2 Quartz CG
TA5 Colonial Grey CG *



RH3 Jet B
20 Charcoal WG *



RH8 Quantum CB
24 Grey Haze WG *



RH9 Cedarstone WG
32 Pebble WG *



RH4 Dolomite WG
460 Cotton W *



RH5 Calcite WG
27 Mist WG *

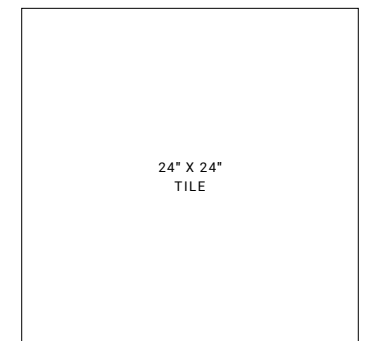
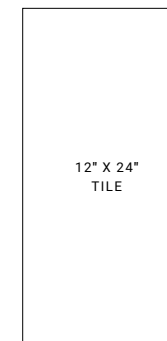

* Suggested Tarkett colors for finishing borders (wall base).
For our complete color offering, reference color guide in back.

Minerality™

RUBBER TILE AND PLANK

Go with
the grain.

The Minerality collection achieves the sophisticated look of natural wood and stone, without the expense and ongoing maintenance of the real thing. Ideal for healthcare, retail and corporate environments, rubber flooring offers slip resistance, shock absorption and acoustic properties—with incredible durability.

Standard in leather texture.

MINERALITY™ STRATA



MRLR-PA1 Marbleite W
27 Mist WG *



MRLR-PA2 Sculpted WG
24 Grey Haze WG *



MRLR-PA3 Marma CB
283 Toast *



MRLR-PA4 Crysta WB
45 Sandalwood WB *



MRLR-PA5 Marbre CB
TA3 Castaway CB *



MRLR-PA6 Carra CG
23 Vapor Grey CG *



MRLR-PA7 Dolo CG
20 Charcoal WG *



MRLR-PA8 Meta WG
55 Silver Grey WG *



MRLR-PA9 Becka CG
TA5 Colonial Grey CG *



MRLR-PB1 Oxide CG
TA4 Gateway WG *

MINERALITY™ GRAINS



MRLR-PB2 Malaga WB
TA2 Saddlebrook WB *



MRLR-PB3 Christo WB
TA7 Rusty Nail *



MRLR-PB4 Mara WG
TB1 Peppercorn *



MRLR-PB5 Woodside WB
TA2 Saddlebrook WB *



MRLR-PB6 Red Walnut WB
TA7 Rusty Nail *



MRLR-PB7 Barnwood WG
TB1 Peppercorn *

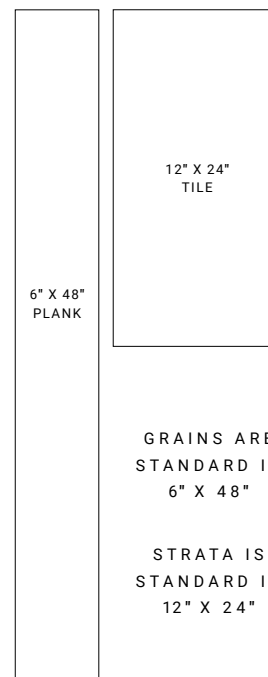

* Suggested Tarkett colors for finishing borders (wall base).
For our complete color offering, reference color guide in back.

Mesto[®] Configurations

RUBBER TILE AND PLANK

Capture
the
outdoors.

Design research suggests that natural elements in a space can promote both learning and healing, so we created a line of marbled rubber tiles—specifically with education and healthcare environments in mind. With three different tones in each of 12 color groupings, you can arrange these tiles and planks in a way that reflects the organic color shifts found in nature.



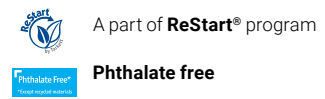

tile sizes
 6"x 6" (152 mm x 152 mm nominal)
 12"x 12" (305 mm x 305 mm nominal)
 24"x 24" (610 mm x 610 mm nominal)

plank sizes
 6"x 24" (152 mm x 610 mm nominal)
 12"x 24" (305 mm x 610 mm nominal)

thickness = .080" (2 mm)
 1/8" (3.175 mm) by special order
adhesives pg. 196

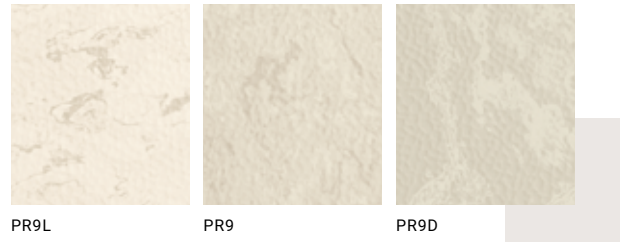

PR9 Story Book
 27 Mist WG *

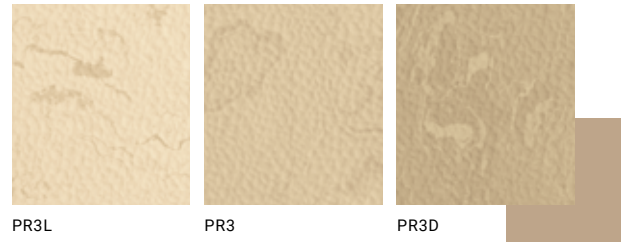

PR3 Gallant Steed
 461 Wicker WB *

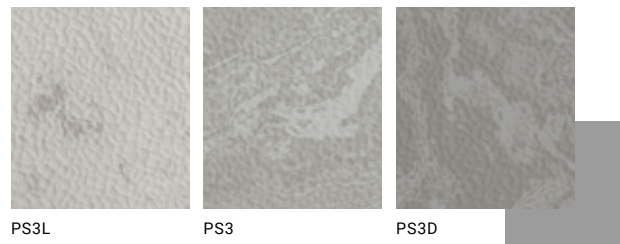

PS3 Noble Knight
 TA5 Colonial Grey CG *

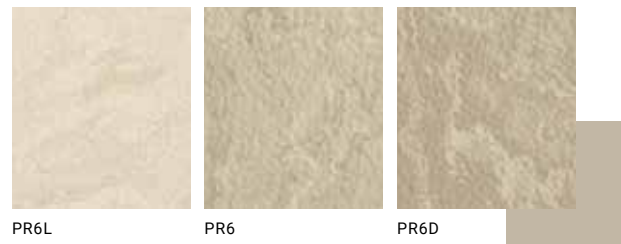

PR6 Mystic Unicorn
 TA3 Castaway CB *

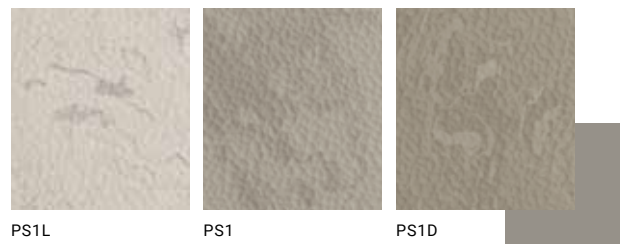

PS1 Sorcerer's Wand
 32 Pebble WG *

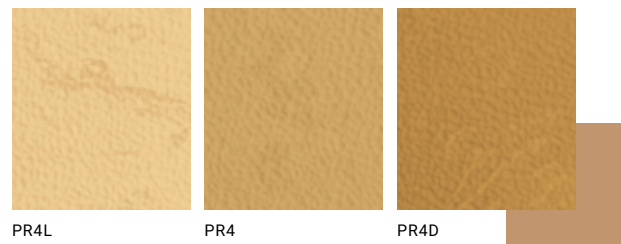

PR4 Golden Slumber
 130 Sisal *

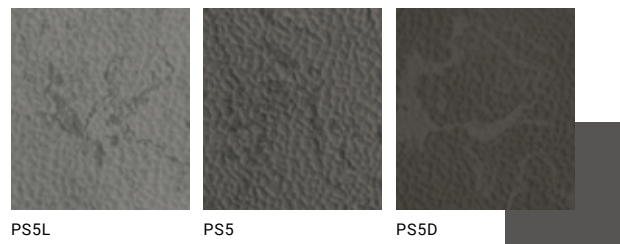

PS5 Maiden Voyage
 TA4 Gateway WG *



PR5 Dragon's Breath
 113 Chestnutty *

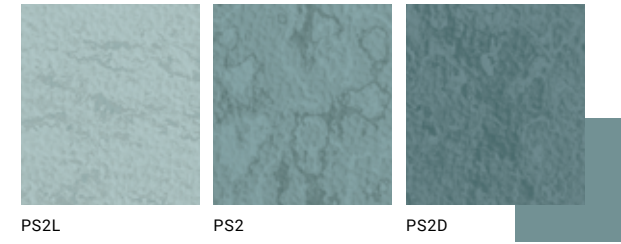

PS2 Glass Slipper
 41 Sea Breeze *



PS4 After Midnight
 TA9 Indigo *

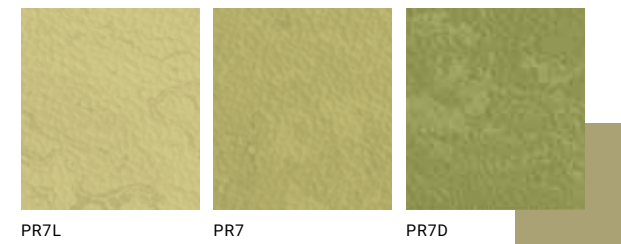

PR7 Enchanted Forest
 151 Iguana *

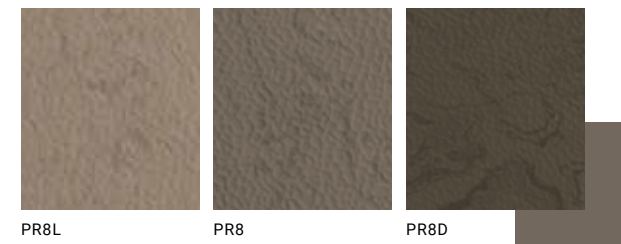

PR8 Troll's Bridge
 283 Toast *

AVAILABLE IN THESE STANDARD TILE SIZES

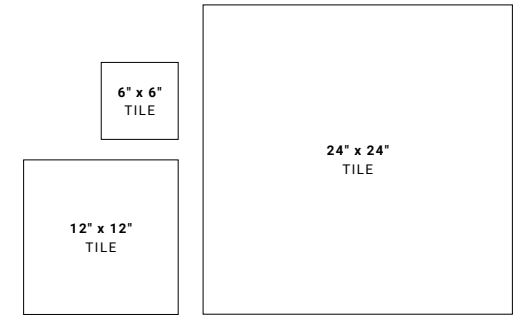

AVAILABLE IN THESE STANDARD PLANK SIZES

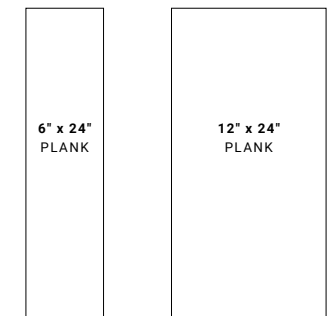

* Suggested Tarkett colors for finishing borders (wall base). For our complete color offering, reference color guide in back.

tile sizes =
12" x 12"
(305 mm x 305 mm nominal)
24" x 24" special order
(610 mm x 610 mm nominal)

thickness = 1/8" (3.175 mm)
standard textures = Hammered,
Rice Paper, Smooth. All others
special order.
Naturally slip resistant

textures pg. 29
adhesives pg. 196



Prima®

RUBBER TILE

Create
your
signature.

Have a design in mind that's so unique, it doesn't exist? Well, not for long. Capture the elegant charm of your space with artful marble or oil-and-water effects. With Prima®, creating your own signature rubber flooring has never been simpler.



Every step is a work of art.

Now you can create your own signature rubber flooring, designing a custom look that also keeps safety, productivity and comfort in mind. Tarkett makes it easy, allowing you to integrate the color and character of your space into your own marbled or oil-and-water effect. Simply select the field and vein colors you wish to incorporate, and contact Tarkett to request a product sample. We'll send you an actual production sample of the colors you've chosen to ensure you're happy with the design before placing your order.

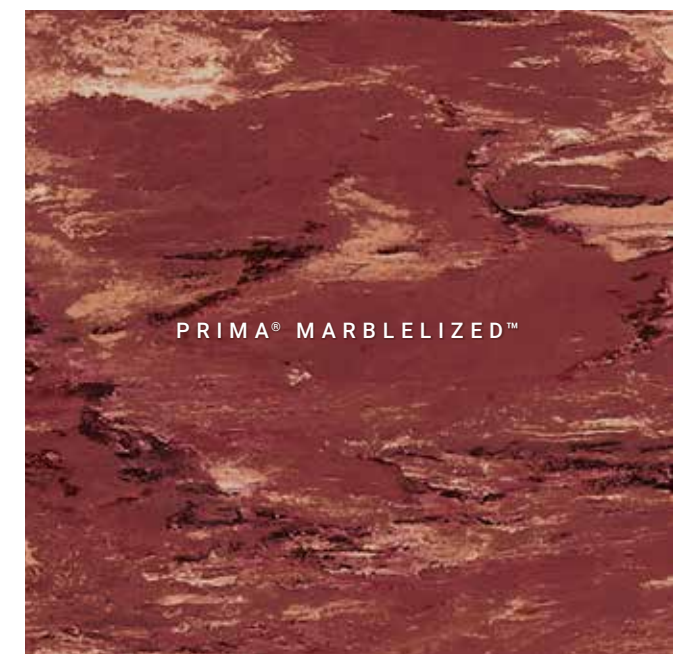
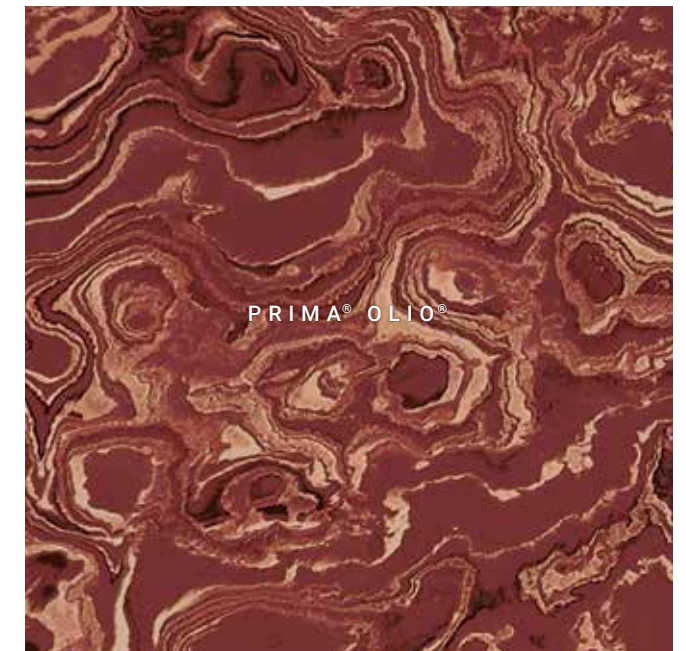

Metallurgy

RUBBER TILE

Posh
meets
practical.

Metallurgy uniquely combines the sophistication of natural metals with the performance of rubber floor tiles. Offering shock and noise absorption, slip resistance, low maintenance, and a dozen authentic colors, this stylish rubber flooring is not only posh—it's practical.

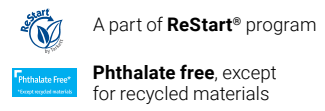
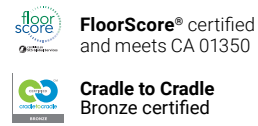

Safer solutions. Daring creativity.

Create authentic-looking metallic floor designs without all the expense or the noise. Offering excellent shock and noise reduction, Metallurgy™ is also naturally slip resistant—proof from Tarkett that a quieter, safer solution can also be daring in design.

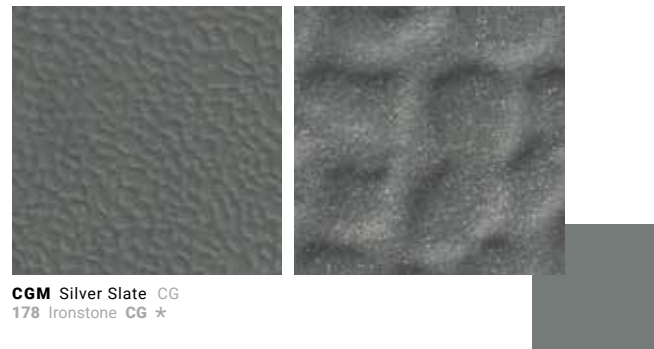
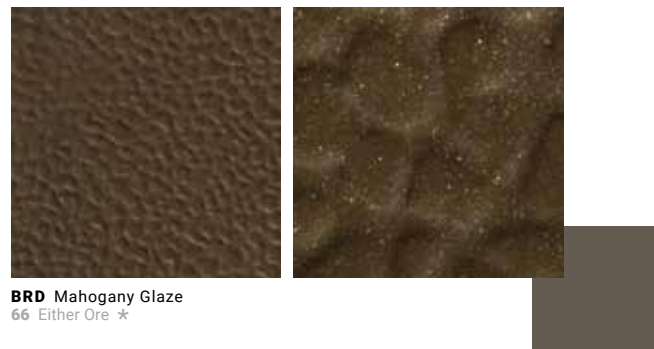
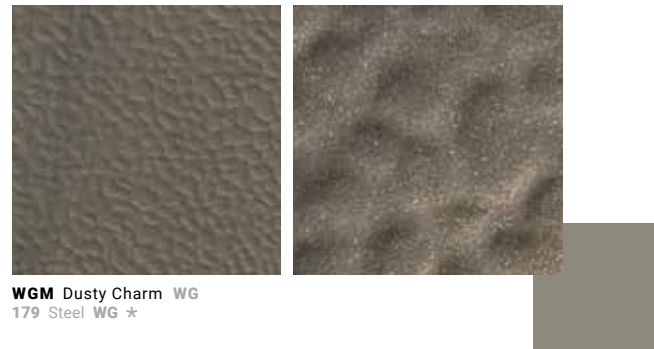
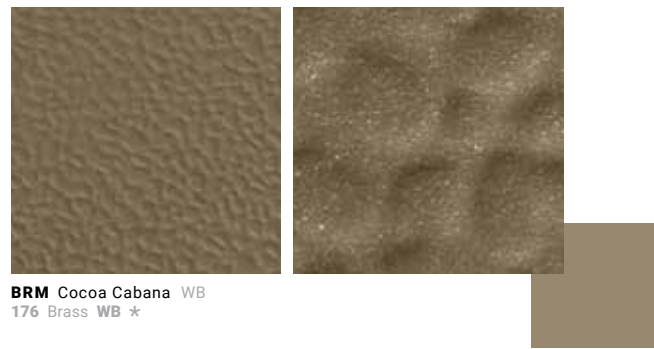
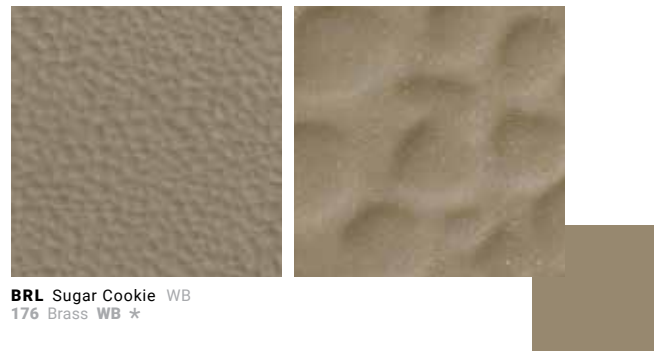

All tiles on right shown at actual size in Hammered texture.

tile size = 24" x 24"
(610 mm x 610 mm nominal)
thickness = 1/8" (3.175 mm)

Metallurgy available in Hammered stair treads. See stair section for details.

textures pg. 29
adhesives pg. 196

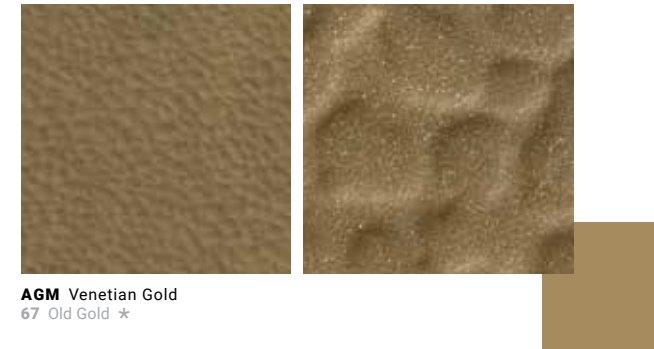
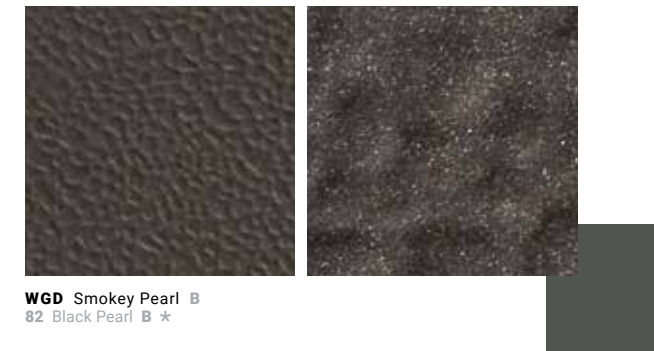
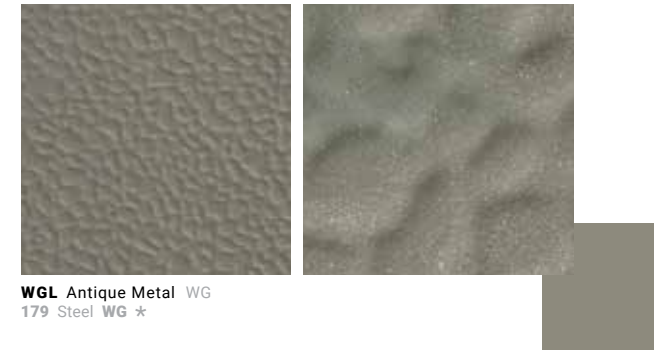
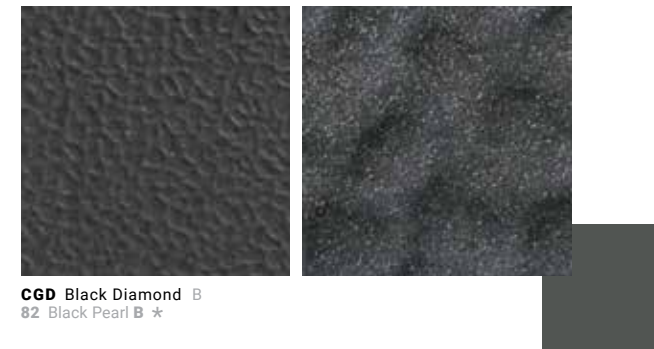

From flooring to bases to transitions, these options were designed to coordinate perfectly. Eliminating guesswork and allowing you to design with ease.

ACCESSORIES AND WALL BASE
67 Old Gold

METALLURGY
AGM Venetian Gold



★ Suggested Tarkett colors for finishing borders (wall base). For our complete color offering, reference color guide in back.

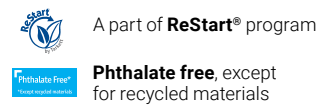
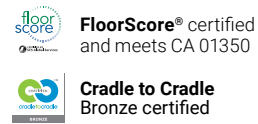

tile size = 24" x 24"
 (610 mm x 610 mm nominal)
thickness = 1/8" (3.175 mm)

Recycled Content
 Pre-consumer 7%
Rapidly Renewable Resources
 All profiles 7%

adhesives pg. 196

Eco-Naturals®

RUBBER TILE

Take a step.

Changing the world starts with small choices that add up to big impact. Choosing a rapidly renewable flooring is a great first step. Eco-Naturals is made with cork (CorkTones™) or a combination of cork and walnut shells (Eco-Shell™), helping specifiers achieve LEED accreditation—and helping all of us take another step toward a more beautiful planet.



Rally Your Resources

Bring together dust from walnuts and cork from pre-consumer waste streams, and you've got Eco-Shell™ with Cork. With 7% by weight renewable and recycled content, these rubber tiles don't stop at eco-friendly. These 24" x 24" textured tiles coordinate easily with other Tarkett flooring, treads and accessories. Plus, they're available in 24 colors, making them ideal for a wide range of projects.

We're committed to developing products that deliver more than just ROI. Our goal is to provide solutions that balance all the competing needs of your space—function and aesthetics, first-time costs and lifetime return, safety and efficiency—with your desire to use products that create less impact on the planet. To learn more about our environmental initiatives, positioning and products, visit tarkettna.com.

ECO-SHELL® WITH CORK RUBBER TILE

DE8 Snow Bird W 01 Snow White W *	DE9 Fossil WB 09 Clay WB *	DN7 Sun Tan WB 49 Beige WB *	DH7 Sandstorm 461 Wicker WB *	DP5 Strand 130 Sisal *	DP6 Nutshell 461 Wicker WB *
DN6 Spot On WB 45 Sandlewood WB *	DQ2 Destiny WB TA7 Rusty Nail *	DP2 Sea Grass 101 Seaweed *	DP3 Timber TA7 Rusty Nail *	DP9 Ruddy TA7 Rusty Nail *	DN9 Spotty 76 Cinnamon *
DQ1 Panache 284 Ganache *	DP8 Appaloosa B 167 Fudge *	DP7 Grass Spots B 150 Wetlands *	DH9 Mars Rock WG 29 Moon Rock WG *	DP1 Baby Deer CB 80 Fawn CB *	DN5 Pacific Storm WG 48 Grey WG *
DJ1 Grainy WG 32 Pebble WG *	DJ2 Ashen CG 38 Pewter CG *	DP4 Deep Sea 469 Mystify CG *	DH8 Lunar Sky WG 20 Charcoal WG *	DN8 Spicy Brown B 63 Burnt Umber B *	DJ3 Spring Nights B 40 Black B *

* Suggested Tarkett colors for finishing borders (wall base). For our complete color offering, reference color guide in back.

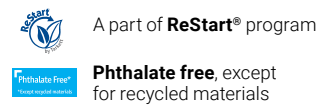
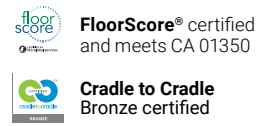

tile size = 24" x 24"
(610 mm x 610 mm nominal)
thickness = 1/8" (3.175 mm)

Recycled Content
Pre-consumer 2.5%

adhesives pg. 196

Rapidly Renewable Resources
All profiles 2.5%

Spec responsibly.

Put conservation into action with CorkTones Rubber Tile, made up of 2.5% rapidly renewable cork. These 24" x 24" tiles are available in 36 ColorMatch® colors (in addition to all the rubber colors available by special order), offer coordinating stair treads with or without risers, and accommodate striping for the visually impaired.

CorkTones RUBBER TILE

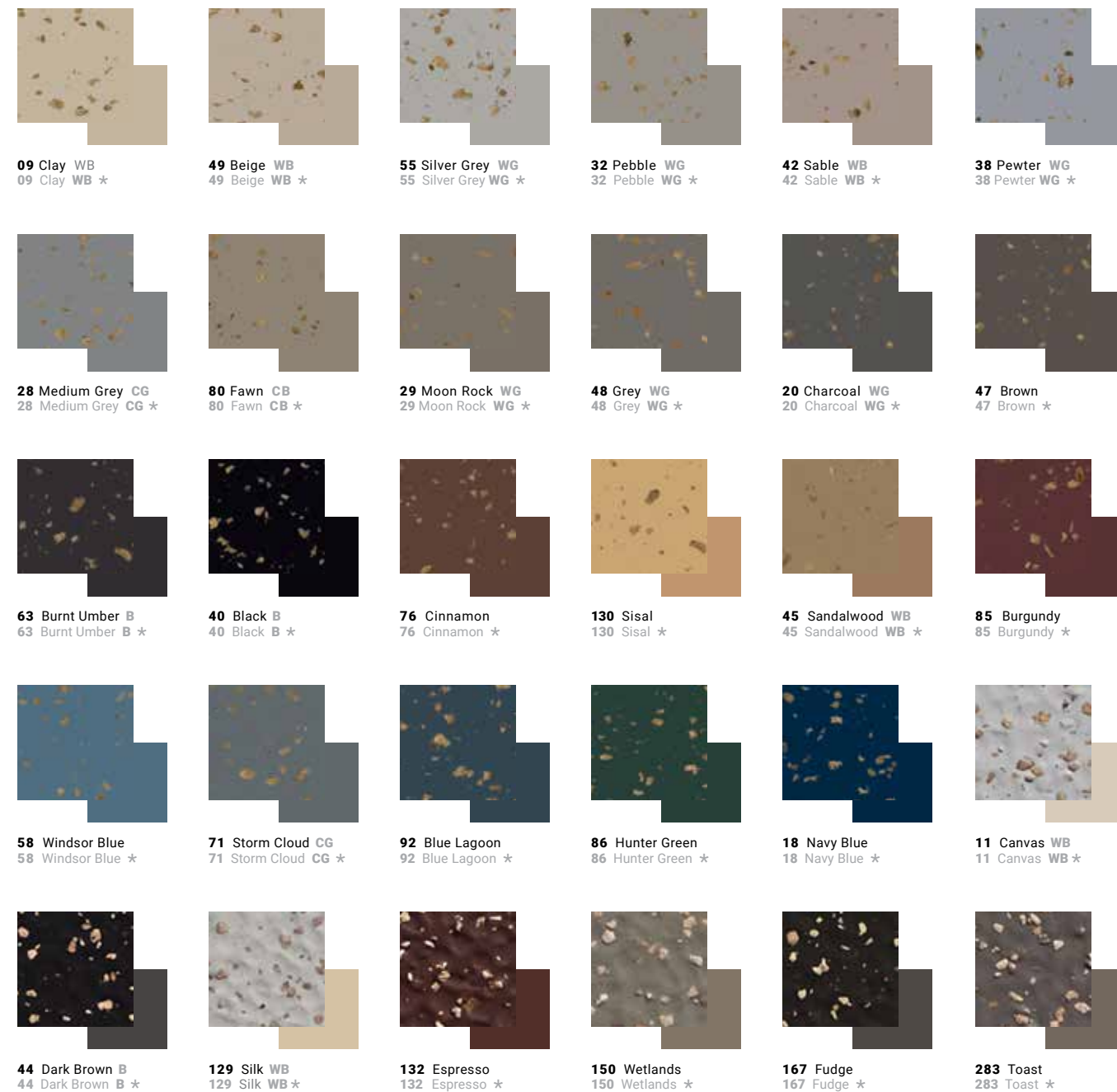

01 Snow White W
01 Snow White W *



34 Almond W
34 Almond W *



22 Pearl CB
22 Pearl CB *



24 Grey Haze WG
24 Grey Haze WG *



31 Zephyr CB
31 Zephyr CB *



21 Platinum CG
21 Platinum CG *

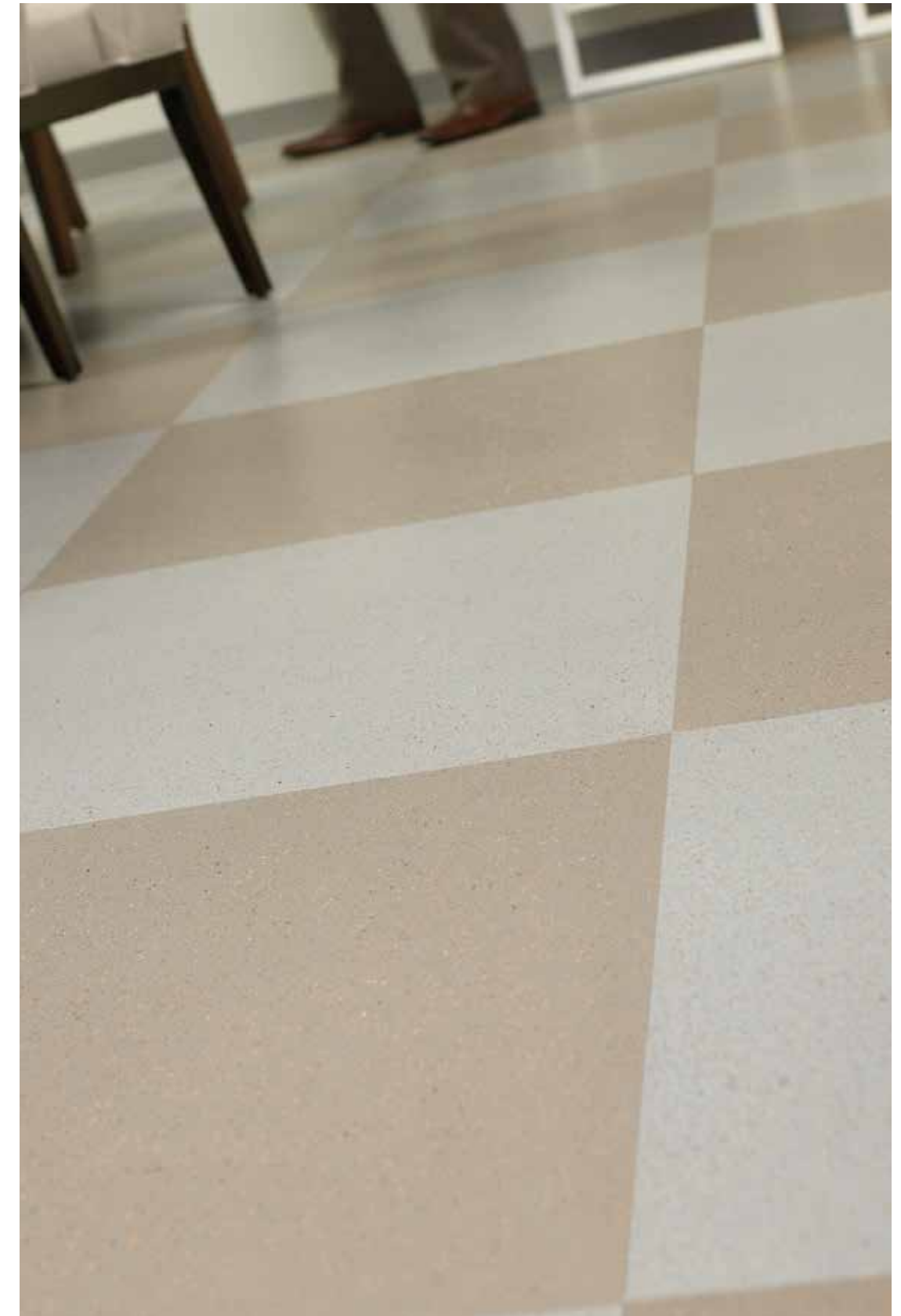

* Suggested Tarkett colors for finishing borders (wall base). For our complete color offering, reference color guide in back.



Linoleum

Harmonium xf²™ Linoleum flooring is made up of four unique collections: Etrusco, Veneto, Lenza and Tonali. Additionally, you can reduce disruptive sounds with Acoustiflor options. It's truly sustainable, beautiful and maintainable. Harmonium xf² is made from 95 percent natural materials that are replenished and naturally abundant.

58
Greys

60
Jewel Tones

59
Greys
Beiges and Browns
Blues and Greens

61
Lenza and Tonali

59
Blues and Greens



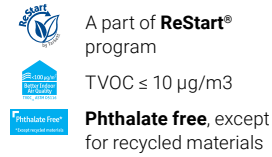
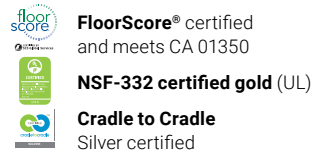

Recycled Content
Pre-consumer 30%

Rapidly Renewable Resources
All SKUs 73%

roll width = 6'6" nominal (2m)
roll length = 65-100 linear feet nominal (20-30 lm)
thickness = see individual pattern for availability

Acoustiflor® options available.
adhesives pg. 196

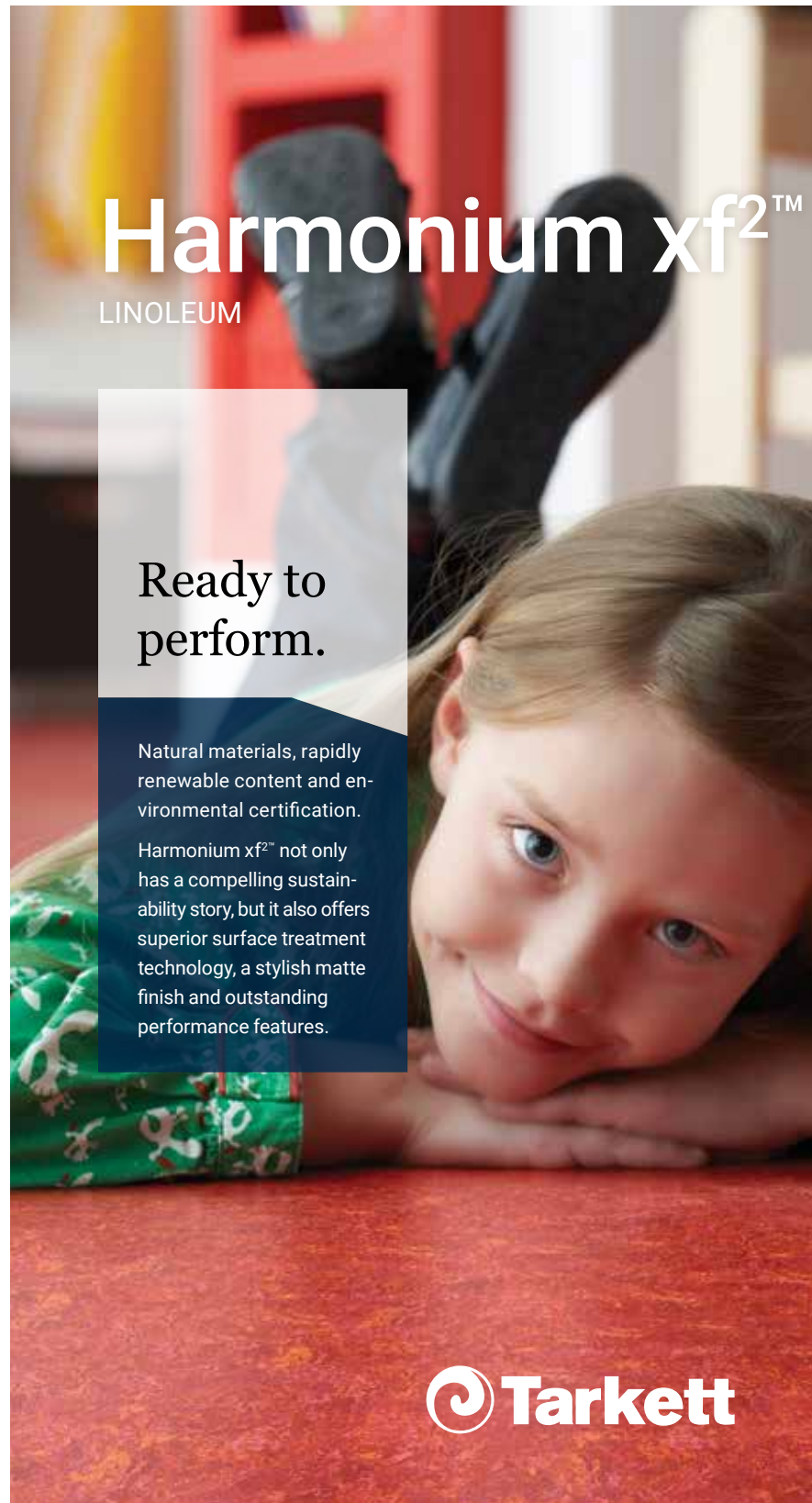

GREYS

Veneto 685 Iced Slate CG Roll 2.5 mm Solid Weld Rod 1751685 262 Drizzle CG *	Veneto 702 Ironed WG Roll 2.0 mm, 2.5mm Solid Weld Rod 1751202 Multicolor 14000702 32 Pebble WG *

Veneto 604 Carlsbad WG Roll 2.0 mm, 2.5mm Solid Weld Rod 1751205 Multicolor 14000604 20 Charcoal WG *	Veneto 608 Northern Lights WG Roll 2.0 mm, 2.5mm Solid Weld Rod 1751608 Multicolor 14000608 29 Moon Rock WG *

Veneto 673 Comet WG Roll 2.0 mm, 2.5mm Solid Weld Rod 1751673 Multicolor 14000673 71 Storm Cloud CG *	Veneto 692 Smoky Mountain CG Roll 2.0 mm, 2.5mm Solid Weld Rod 1751692 28 Medium Grey CG *

Veneto 906 Grizzled B Roll 2.0 mm, 2.5mm Solid Weld Rod 1751906 Multicolor 14000906 40 Black B *	Veneto 674 Falling Star B Roll 2.0 mm, 2.5mm Solid Weld Rod 1751098 Multicolor 14000674 40 Black B *

*Suggested Tarkett colors for finishing borders (wall base). For our complete color offering, reference color guide in back.

Color Foundations™ is our commitment to always have representation across 6 key neutral palettes. We've identified Color Foundations neutrals in the following way: WB (warm beige), CB (cool beige), WG (warm grey), CG (cool grey), B (black), W (white).

The Solid and Multicolor Weld Rods listed are coordinating recommendations. Other color weld rods can be used for a variety of visual effects.

Veneto 2.0 mm is a standard non-stocking item available in full rolls. Call for availability.



GREYS (CONT.)

Veneto 703 Shaded WG Roll 2.5mm Solid Weld Rod 1751703 55 Silver Grey WG *

Veneto 704 Becloud WG Roll 2.5mm Solid Weld Rod 1751205 20 Charcoal WG *

Veneto 686 Deep Space CG Roll 2.5mm Solid Weld Rod 1751686 71 Storm Cloud CG *

Veneto 610 Bituminous B Roll 2.0 mm, 2.5mm Solid Weld Rod 1751098 Multicolor 14000610 40 Black B *

BEIGES AND BROWNS

Veneto 700 Frost W Roll 2.5mm Solid Weld Rod 1751700 01 Snow White W *

Veneto 611 Moonstone WB Roll 2.0 mm, 2.5 mm Solid Weld Rod 1751611 Multicolor 14000611 461 Wicker WB *

Veneto 711 Pleasant WB Roll 2.0 mm, 2.5 mm Solid Weld Rod 1751611 Multicolor 14000711 461 Wicker WB *

Veneto 619 Carnelian Roll 2.5mm Solid Weld Rod 1751619 34 Almond W *

Veneto 601 Cloud Nine CB Roll 2.5mm Solid Weld Rod 1751601 22 Pearl CB *

Veneto 911 Burlap WB Roll 2.5mm Solid Weld Rod 1751625 11 Canvas WB *

Veneto 710 Lively WB Roll 2.0 mm, 2.5 mm Solid Weld Rod 1751611 Multicolor 14000710 129 Silk WB *

Veneto 400 Natural Clay WB Roll 2.5mm Solid Weld Rod 1751400 112 Oakley *

Veneto 622 Geode WB Roll 2.5mm Solid Weld Rod 1751611 129 Silk WB *

Veneto 637 Au Lait CG Roll 2.5mm Solid Weld Rod 1751121 22 Pearl CG *

Veneto 679 Mesa Roll 2.0 mm, 2.5 mm Solid Weld Rod 1751611 Multicolor 14000679 19 Desert Camel *

Veneto 712 Good Natured WB Roll 2.5mm Solid Weld Rod 1751313 130 Sisal *

Veneto 624 Azurite WB Roll 2.5 mm Solid Weld Rod 1751619 129 Silk WB *

Veneto 625 Arizona Tan WB Roll 2.5mm Solid Weld Rod 1751625 09 Clay WB *

Veneto 121 Durango WB Roll 2.5mm Solid Weld Rod 1751121 09 Clay WB *

Veneto 631 Warm Day Roll 2.5mm Solid Weld Rod 1751631 286 Fortune Cookie *

BLUES AND GREENS

Veneto 663 Lighthouse Roll 2.0 mm, 2.5 mm Solid Weld Rod 1751660 Multicolor 14000663 139 Glacier *

Veneto 764 Violetta Roll 2.5 mm Solid Weld Rod 1751764 465 Seafarer *

Etrusco 003 Ashen CG Roll 2.5 mm Solid Weld Rod 1751692 28 Medium Grey CG *

Veneto 671 Silver Lining CG Roll 2.0 mm, 2.5 mm Solid Weld Rod 1751671 Multicolor 14000671 262 Drizzle CG *

Veneto 739 Clay Court Roll 2.5mm Solid Weld Rod 1751739 259 Terra Firma *

Veneto 919 Tumeric Roll 2.5mm Solid Weld Rod 1751919 112 Oakley *

Veneto 524 Tiger Eye Roll 2.5mm Solid Weld Rod 1751524 76 Cinnamon *

Veneto 632 Garnet Roll 2.5mm Solid Weld Rod 1751632 284 Ganache *

Veneto 756 Sprouting Roll 2.5 mm Solid Weld Rod 1751756 593 Duckweed *

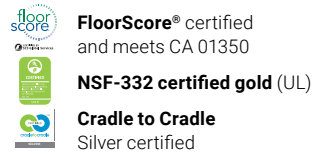

FloorScore® certified and meets CA 01350

NSF-332 certified gold (UL)

Cradle to Cradle Silver certified

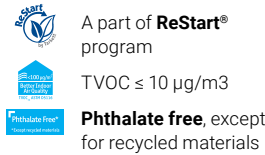

A part of ReStart® program

TVOC ≤ 10 µg/m³

Phthalate free, except for recycled materials

Recycled Content
Pre-consumer 30%

Rapidly Renewable Resources
All SKUs 73%

roll width = 6'6" nominal (2m)
roll length = 65-100 linear feet nominal (20-30 lm)

thickness = see individual pattern for availability
adhesives pg. 196

BLUES AND GREENS (CONT.)

JEWEL TONES

LENZA AND TONALI

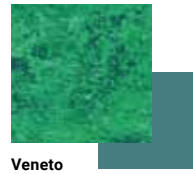

Veneto
651 Sea
Roll 2.5 mm
Solid Weld Rod 1751651
147 South Seas *



Veneto
670 Blue Agave
Roll 2.5 mm
Solid Weld Rod 1751670
84 Blue Jeans *

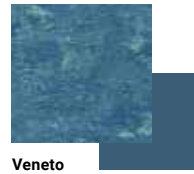

Veneto
665 Penninsula
Roll 2.5 mm
Solid Weld Rod 1751665
84 Blue Jeans *



Veneto
612 Dandelion
Roll 2.0 mm, 2.5 mm
Solid Weld Rod 1751219
Multicolor 14000612
460 Cotton W *



Veneto
628 Sunflower
Roll 2.5 mm
Solid Weld Rod 1751628
273 Copper Penny *



Veneto
634 Daisy
Roll 2.5 mm
Solid Weld Rod 1751636
473 Butterscotch *



Veneto
760 Lakeside
Roll 2.5 mm
Solid Weld Rod 1751670
58 Windsor Blue *

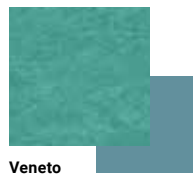

Veneto
761 Bay
Roll 2.5 mm
Solid Weld Rod 1751671
192 Tidewater *



Veneto
650 Rainforest
Roll 2.0 mm, 2.5 mm
Solid Weld Rod 1751650
Multicolor 14000650
471 Bok Choy *



Veneto
636 Day Lily
Roll 2.0 mm, 2.5 mm
Solid Weld Rod 1751636
Multicolor 14000636
273 Copper Penny *



Veneto
641 Towpath Trail
Roll 2.0 mm, 2.5 mm
Solid Weld Rod 1751641
Multicolor 14000641
140 Carrot *



Veneto
744 Kilauea
Roll 2.5 mm
Solid Weld Rod 1751744
148 Paprika *



Veneto
757 Grown Green
Roll 2.5 mm
Solid Weld Rod 1751757
190 Greege *

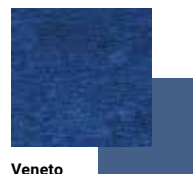

Veneto
767 Magestic
Roll 2.5 mm
Solid Weld Rod 1751220
465 Seafarer *



Veneto
688 Downpour
Roll 2.5 mm
Solid Weld Rod 1751220
70 Bluest *



Veneto
740 Blaze
Roll 2.5 mm
Solid Weld Rod 1751740
163 Salsa *



Veneto
945 Russet
Roll 2.5 mm
Solid Weld Rod 1751945
113 Chestnutty *



Veneto
742 Viola
Roll 2.5 mm
Solid Weld Rod 1751049
162 Sovereign *

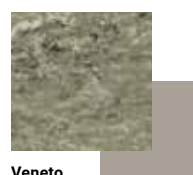

Veneto
714 Aloof CB
Roll 2.5 mm
Solid Weld Rod 1751303
121 Cement CB *



Veneto
502 Fossil WB
Roll 2.5 mm
Solid Weld Rod 1751502
280 Shoreline *



Veneto
684 Cascade WG
Roll 2.5 mm
Solid Weld Rod 1751793
24 Grey Haze WB *

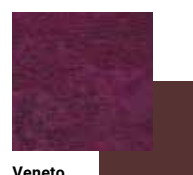

Veneto
741 Blooming
Roll 2.5 mm
Solid Weld Rod 1751094
85 Burgundy *



Etrusco
094 Auburn
Roll 2.5 mm
Solid Weld Rod 1751094
85 Burgundy *



Etrusco
048 Indeed
Roll 2.5 mm
Solid Weld Rod 1751048
472 Imperial *

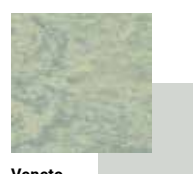

Veneto
793 Mirage CG
Roll 2.0 mm, 2.5 mm
Solid Weld Rod 1751793
Multicolor 14000793
23 Vapor Grey CG *

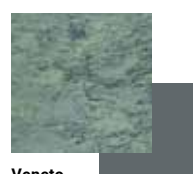

Veneto
672 Twilight WG
Roll 2.0 mm, 2.5 mm
Solid Weld Rod 1751672
Multicolor 14000672
71 Storm Cloud CG *

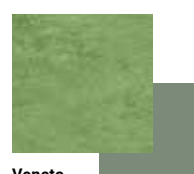

Veneto
753 Sherwood
Roll 2.5 mm
Solid Weld Rod 1751753
289 Jaded *



Veneto
754 Budding
Roll 2.5 mm
Solid Weld Rod 1751754
271 Seedling *



Etrusco
053 Echo
Roll 2.5 mm
Solid Weld Rod 1751053
271 Seedling *



Etrusco
054 Beryl
Roll 2.5 mm
Solid Weld Rod 1751054
147 South Seas *



Lenza
202 Aged Concrete WG
Roll 2.5 mm
Solid Weld Rod 1751202
55 Silver Grey WG *

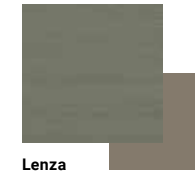

Lenza
303 Thicket WG
Roll 2.5 mm
Solid Weld Rod 1751303
281 Grizzly WG *



Tonali
203 Agrarian WG
Roll 2.5 mm
Solid Weld Rod 1751203
281 Grizzly WG *



Lenza
300 Warm Biscuit
Roll 2.5 mm
Solid Weld Rod 1751300
129 Silk WB *

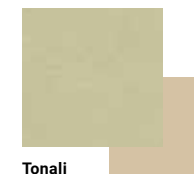

Tonali
200 Hummus
Roll 2.5 mm
Solid Weld Rod 1751200
129 Silk WB *



Tonali
201 Spanish Stucco WB
Roll 2.5 mm
Solid Weld Rod 1751201
09 Clay WB *

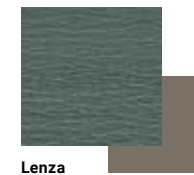

Lenza
305 Carbonize WG
Roll 2.5 mm
Solid Weld Rod 1751205
29 Moon Rock WG *



Tonali
205 Rustic Pathway WG
Roll 2.5 mm
Solid Weld Rod 1751205
29 Moon Rock WG *

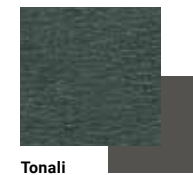

Tonali
207 Shaded Walkway WG
Roll 2.5 mm
Solid Weld Rod 1751207
20 Charcoal WG *



Tonali
216 Celestial Temple
Roll 2.5 mm
Solid Weld Rod 1751216
264 Grounded *

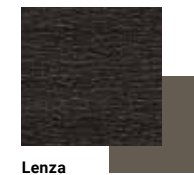

Lenza
317 Landing Pier
Roll 2.5 mm
Solid Weld Rod 1751621
66 Either Ore *



Tonali
217 Venetian Fresco
Roll 2.5 mm
Solid Weld Rod 1751621
66 Either Ore *



Tonali
208 Sierra WB
Roll 2.5 mm
Solid Weld Rod 1751313
19 Desert Camel *



Lenza
308 Straw Hat WB
Roll 2.5 mm
Solid Weld Rod 1751313
19 Desert Camel *

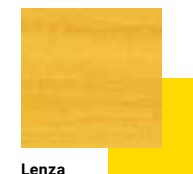

Lenza
319 Sunrise
Roll 2.5 mm
Solid Weld Rod 1751219
75 Lemon *

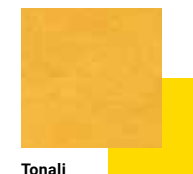

Tonali
219 Sun Time
Roll 2.5 mm
Solid Weld Rod 1751219
75 Lemon *



Tonali
218 Glowing
Roll 2.5 mm
Solid Weld Rod 1751037
62 Tangerne Tango *

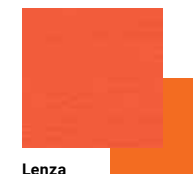

Lenza
318 Flashy
Roll 2.5 mm
Solid Weld Rod 1751037
62 Tangerne Tango *

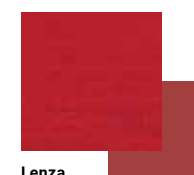

Lenza
314 Rosie
Roll 2.5 mm
Solid Weld Rod 1751214
294 Big Top *

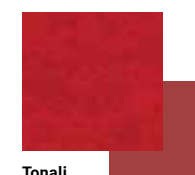

Tonali
214 Real Red
Roll 2.5 mm
Solid Weld Rod 1751214
294 Big Top *



Tonali
215 Limeade
Roll 2.5 mm
Solid Weld Rod 1751215
475 Marshland *



Lenza
315 Alight Lime
Roll 2.5 mm
Solid Weld Rod 1751215
475 Marshland *



Lenza
320 Astute
Roll 2.5 mm
Solid Weld Rod 1751220
18 Navy Blue *

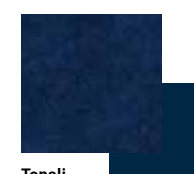

Tonali
220 Engaged
Roll 2.5 mm
Solid Weld Rod 1751220
18 Navy Blue *

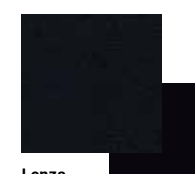

Lenza
309 Dark Obsidian B
Roll 2.5 mm
Solid Weld Rod 1751309
40 Black B *

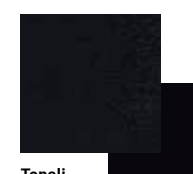

Tonali
209 Black Charcoal B
Roll 2.5 mm
Solid Weld Rod 1751209
40 Black B *

* Suggested Tarkett colors for finishing borders (wall base).
For our complete color offering, reference color guide in back.

Color Foundations™ is our commitment to always have representation across 6 key neutral palettes. We've identified Color Foundations neutrals in the following way:
WB (warm beige), CB (cool beige), WG (warm grey), CG (cool grey), B (black), W (white).

The Solid and Multicolor Weld Rods listed are coordinating recommendations.
Other color weld rods can be used for a variety of visual effects.

Veneto 2.0 mm is a standard non-stocking item available in full rolls. Call for availability.



Luxury Vinyl Tile

With uncompromising style, comfort, performance, and sustainability, our luxury vinyl tiles and planks deliver everything you've ever wanted in a floor.

64

I.D. Inspiration™

78

I.D. Freedom™
Woods

70

I.D. Freedom™
Abstracts

82

I.D. Principle

74

I.D. Freedom™
Stones

84

Transcend™ SureSet™

Johnsonite offers a perfectly balanced lineup of high-performing LVT in tiles and planks that coordinates seamlessly with our other flooring materials, wall bases and accessories. With so many sizes, colors, and patterns to choose from, our full line of LVT means you'll never be void of inspiration.



Menu

Starters

Red Pepper soup	8
Almond, Mint & Ricotta Salad	14
Anchovies on Dried Tomatoes	16
Tuna and Lime Ceviche	16

Entrees

Californian Salmon Tartar	24
Sesame Tuna Steak	28
Fresh cod & Tomatillo Sauce	30
Black Angus Filet & Broccoli puree	34

Desserts

Pineapple Pie & Mango Sorbet	9
Chocolate Mousse Zabaglione	10
Apple Caramel	12
Miso	14

I.D. Inspiration™

LUXURY VINYL TILE

Born to
innovate.

Durability and lifelike design are in I.D. Inspiration's DNA. Recently updated to include 30 colors, 24 plank wood designs from a classically trained European woodworker, and 6 tiles. The 6 tiles feature all-new designs, bringing abstract, stone and woven patterns to the once all-woods collection. An advanced engraving technique provides superior attention to detail for graining, texture and color on color. The result is a beautiful floor that remains so for years.

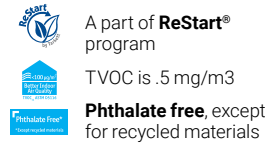
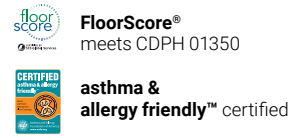

Recycled Content
Pre-consumer 32%

plank sizes =

ID70: 24201: 7.87" x 48"
(20cm x 122cm)

ID70: 24205: 6.56" x 39.37"
(16.66cm x 100cm)

ID55: 24231: 7.87" x 48"
(20cm x 122cm)

ID55: 24235: 6.56" x 39.37"
(16.66cm x 100cm)

tiles =

ID70: 24207: 19.68" x 19.68"
(50cm x 50cm)

ID55: 24237: 19.68" x 19.68"
(50cm x 50cm)

thickness = .10" (2.5 mm)

adhesives pg. 196



ID70: 24201001 ID55: 24231001
Antik Oak | Beige WB
TA3 Castaway WB *



ID70: 24201003 ID55: 24231003
Antik Oak | Dark Grey WG
55 Silver Grey WG *



ID70: 24201029 ID55: 24231029
English Oak | Grey Beige CB
121 Cement CB *

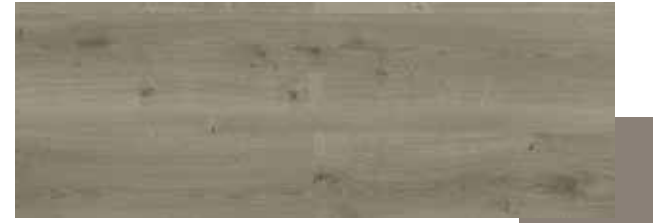

ID70: 24201122 ID55: 24231122
Rustic Oak | Dark Grey CB
TA8 Welsh Castle CB *



ID70: 24201109 ID55: 24231109
Contemporary Oak | Grey CB
469 Mystify CG *



ID70: 24201007 ID55: 24231007
Antik Oak | Anthracite WG
32 Pebble WG *



ID70: 24201092 ID55: 24231092
Vintage Teak | Grey CB
TB1 Peppercorn CB *



ID70: 24201093 ID55: 24231093
Vintage Teak | Natural WB
TA2 Saddlebrook WB *



ID70: 24201008 ID55: 24231008
Antik Oak | Middle Grey CB
121 Cement CB *



ID70: 24201111 ID55: 24231111
Contemporary Oak | Natural WB
09 Clay WB *



ID70: 24205009 ID55: 24235009
Wenge | Black B
44 Dark Brown B *



ID70: 24201100 ID55: 24231100
Scandinavian Oak | Light Beige WB
TA3 Castaway WB *



ID70: 24201013 ID55: 24231013
Brushed Pine | Brown WB
45 Sandalwood WB *



ID70: 24201024 ID55: 24231024
English Oak | Beige CB
195 Ash WG *



ID70: 24201108 ID55: 24231108
Patina Ash | Grey WG
55 Silver Grey WG *



ID70: 24205011 ID55: 24235011
Wenge | Grey CG
TA4 Gateway WG *



ID70: 24201115 ID55: 24231115
Elm | Natural WB
461 Wicker WB *



ID70: 24201025 ID55: 24231025
English Oak | Brown WB
49 Beige WB *



ID70: 24201113 ID55: 24231113
Elm | Light Grey W
24 Grey Haze WG *



ID70: 24201110 ID55: 24231110
Contemporary Oak | Grege CB
31 Zephyr CB *

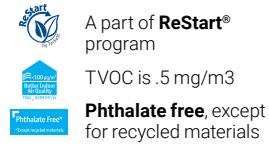
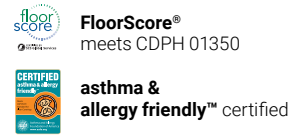

Recycled Content
Pre-consumer 32%

plank sizes =

ID70: 24201: 7.87" x 48"
(20cm x 122cm)

ID55: 24231: 7.87" x 48"
(20cm x 122cm)

ID70: 24205: 6.56" x 39.37"
(16.66cm x 100cm)

ID55: 24235: 6.56" x 39.37"
(16.66cm x 100cm)

tiles =

ID70: 24207: 19.68" x 19.68"
(50cm x 50cm)

ID55: 24237: 19.68" x 19.68"
(50cm x 50cm)

thickness = .10" (2.5 mm)

adhesives pg. 196



ID70: 24205012 ID55: 24235012
Wenge | Greige CB
TA6 Welsh Castle CB *



ID70: 24201128 ID55: 24231128
Rustic Oak | Medium Brown WB
101 Seaweed WB *



ID70: 24205010 ID55: 24235010
Wenge | Natural
47 Brown *



ID70: 24201121 ID55: 24231121
Rustic Oak | Stone Brown
44 Dark Brown B *

I.D. INSPIRATION™ TILES



ID70: 24207082 ID55: 24237082
Tisse | Beige CB
TA6 Welsh Castle CB *

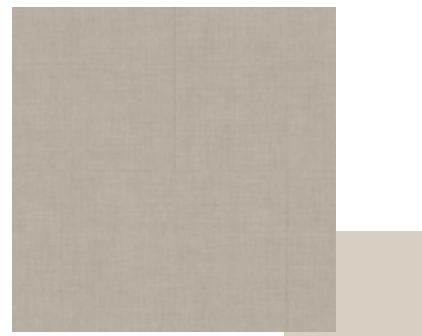

ID70: 24207084 ID55: 24237084
Tisse | Light CB
24 Grey Haze WG *

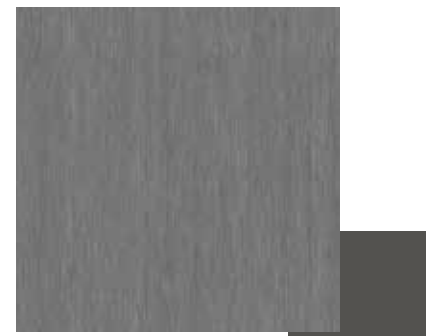

ID70: 24207088 ID55: 24237088
Trend Line | Black B
20 Charcoal WG *



ID70: 24207090 ID55: 24237090
Trend Line | Silver CG
TA5 Colonial Grey CG *



ID70: 24207094 ID55: 24237094
Vintage Zinc | Black B
63 Burnt Umber B *



ID70: 24207120 ID55: 24237120
Oxide | Black Steel CG
TA4 Gateway WG *

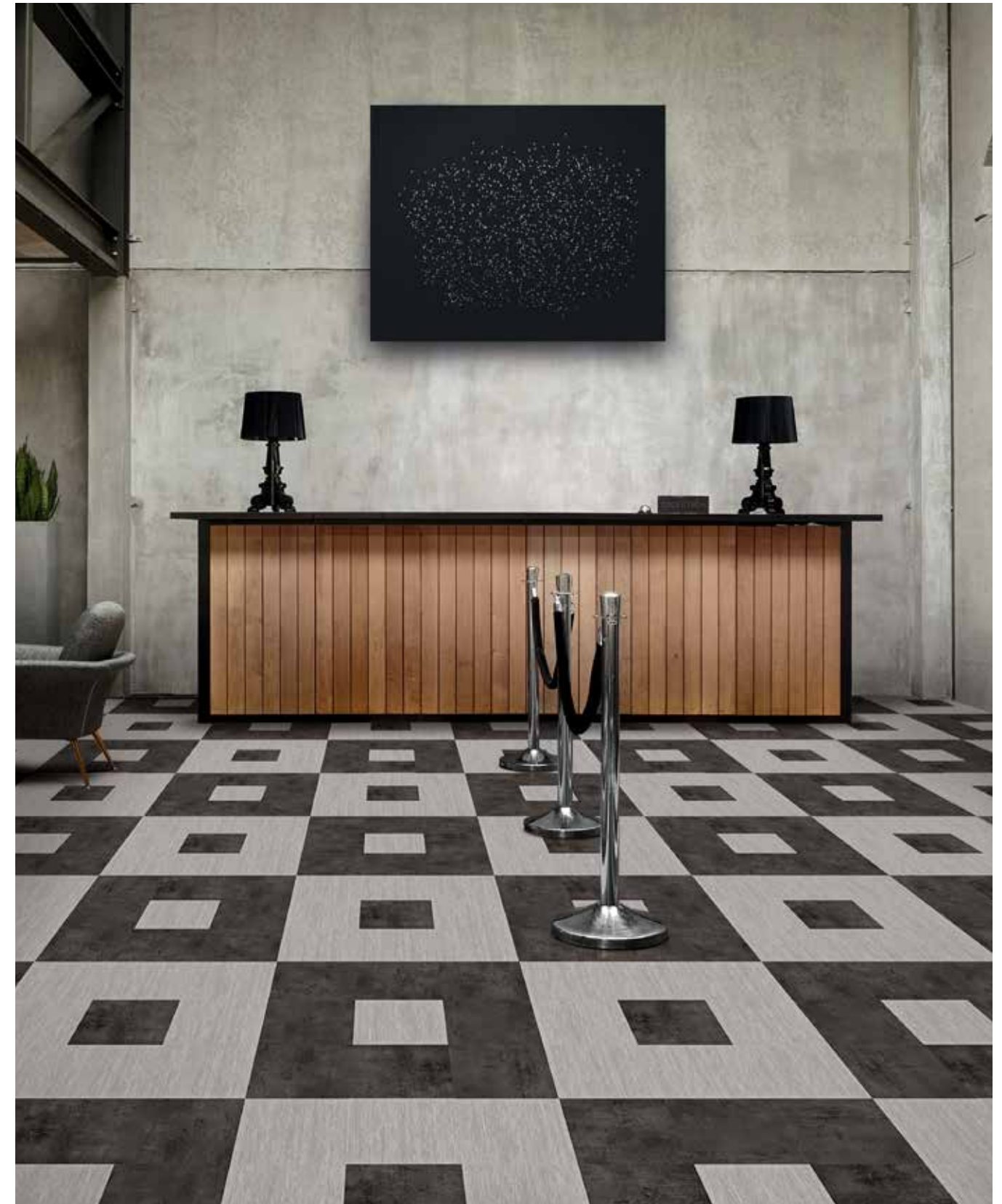



I.D. Freedom™ Abstracts

LUXURY VINYL TILE

Forgo familiar.

Familiar is fine. However, when you deconstruct the familiar, the conversation gets a little more interesting. Why not weave strands of metal into a familiar fabric? Or build textiles out of weathered wood? I.D. Freedom™ accepted the challenge and combined familiar patterns and materials into dramatic configurations. The resulting collection of planks and tiles is like nothing you've seen before.



thickness = .125" (3.18 mm)
adhesives pg. 196



Pace | Warm Grey WG
29 Moon Rock WG *
(S) FRE-T 3563, size 18" x 18"
(SO) Not Applicable

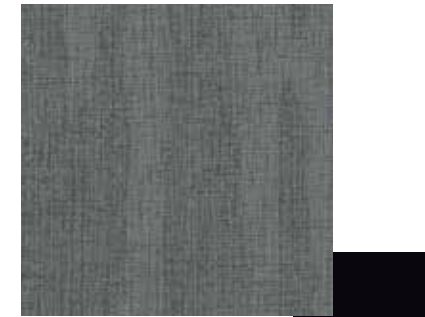

Unravel | Charcoal B
40 Black B *
(S) FRE-T 3575, size 18" x 18"
(SO) FP3575636, size 6" x 36"



Unravel | Grey Teal
41 Sea Breeze *
(S) FRE-T 3577, size 18" x 18"
(SO) FP3577636, size 6" x 36"



Unravel | Warm Grey WG
29 Moon Rock WG *
(S) FRE-T 3573, size 18" x 18"
(SO) FP3573636, size 6" x 36"



Unravel | Deep Blue
18 Navy Blue *
(S) FRE-T 3576, size 18" x 18"
(SO) FP3576636, size 6" x 36"



Unravel | Green
190 Greege *
(S) FRE-T 3578, size 18" x 18"
(SO) FP3578636, size 6" x 36"



Rays | Warm Beige WB
461 Wicker WB *
(S) FRE-T 3584, size 18" x 18"
(SO) Not Applicable



Rays | Warm Neutral W
50 White W *
(S) FRE-T 3581, size 18" x 18"
(SO) Not Applicable



Rays | Cool Beige CB
280 Shoreline *
(S) FRE-T 3583, size 18" x 18"
(SO) Not Applicable



Unravel | Warm Brown
76 Cinnamon *
(S) FRE-T 3579, size 18" x 18"
(SO) FP3579636, size 6" x 36"

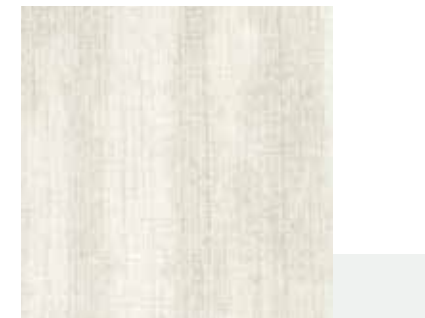

Unravel | Soft Neutral LT W
50 White W *
(S) FRE-T 5710, size 18" x 18"
(SO) FP5710636, size 6" x 36"



Rays | Cool Grey CG
23 Vapor Grey CG *
(S) FRE-T 3582, size 18" x 18"
(SO) Not Applicable

* Suggested Tarkett colors for finishing borders (wall base). For our complete color offering, reference color guide in back.



Pace | Warm Beige WB
461 Wicker WB *
(S) FRE-T 3561, size 18" x 18"
(SO) Not Applicable

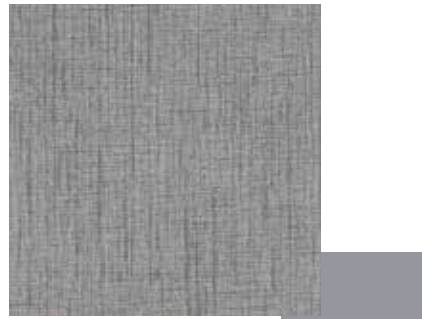

Pace | Cool Grey CG
38 Pewter CG *
(S) FRE-T 3564, size 18" x 18"
(SO) Not Applicable



Unravel | Warm Beige WB
45 Sandalwood WB *
(S) FRE-T 3571, size 18" x 18"
(SO) FP3571636, size 6" x 36"



Unravel | Cool Grey CG
38 Pewter CG *
(S) FRE-T 3574, size 18" x 18"
(SO) FP3574636, size 6" x 36"



Pace | Cool Beige CB
280 Shoreline *
(S) FRE-T 3562, size 18" x 18"
(SO) Not Applicable



TexGrain | Charcoal B
44 Dark Brown B *
(S) FRE-T 3545, size 18" x 18"
(SO) Not Applicable



TexGrain | Cool Grey CG
TG2 Sharkfin CG *
(S) FRE-T 3541, size 18" x 18"
(SO) Not Applicable



Unravel | Cool Beige CB
280 Shoreline *
(S) FRE-T 3572, size 18" x 18"
(SO) FP3572636, size 6" x 36"



TexMode | Charcoal B
44 Dark Brown B *
(S) FRE-T 3555, size 18" x 18"
(SO) Not Applicable



TexGrain | Cool Beige CB
80 Fawn CB *
(S) FRE-T 3542, size 18" x 18"
(SO) Not Applicable



TexMode | Cool Beige CB
80 Fawn CB *
(S) FRE-T 3552, size 18" x 18"
(SO) Not Applicable



TexMode | Cool Grey CG
TG2 Sharkfin CG *
(S) FRE-T 3551, size 18" x 18"
(SO) Not Applicable



TexMode | Golden WB
461 Wicker WB *
(S) FRE-T 3553, size 18" x 18"
(SO) Not Applicable



TexMode | Warm Brown
76 Cinnamon *
(S) FRE-T 3554, size 18" x 18"
(SO) Not Applicable



TexLine | Cool Grey CG
TG2 Sharkfin CG *
(S) FRE-T 3531, size 18" x 18"
(SO) Not Applicable



TexLine | Charcoal B
44 Dark Brown B *
(S) FRE-T 3535, size 18" x 18"
(SO) Not Applicable



TexLine | Cool Beige CB
80 Fawn CB *
(S) FRE-T 3532, size 18" x 18"
(SO) Not Applicable



TexLine | Warm Brown
76 Cinnamon *
(S) FRE-T 3534, size 18" x 18"
(SO) Not Applicable



TexLine | Golden WB
461 Wicker WB *
(S) FRE-T 3533, size 18" x 18"
(SO) Not Applicable



TexGrain | Warm Brown
76 Cinnamon *
(S) FRE-T 3544, size 18" x 18"
(SO) Not Applicable



TexGrain | Golden WB
461 Wicker WB *
(S) FRE-T 3543, size 18" x 18"
(SO) Not Applicable

* Suggested Tarkett colors for finishing borders (wall base). For our complete color offering, reference color guide in back.

Sizes available: (S) = Standard, (SO) = Special Order



I.D. Freedom™ Stones

LUXURY VINYL TILE

Pave
the way.

We've actually done it. We've left no stone unturned. We've taken the natural beauty, markings and coloration of stone and we've reimagined them. We've washed, worn, rusted, stained and steeped stone in coordinated color. From classic Travertines to element-blending Meta-Stone, our I.D. Freedom™ Stones are paving the way to greatness. Enjoy the journey.



thickness = .125" (3.18 mm)
adhesives pg. 196



Concrete | Gypsum CB
31 Zephyr CB *
(S) FRE-T 3511, size 18" x 18"
(SO) FT35111836, size 18" x 36"



Concrete | Alumin CG
23 Vapor Grey CG *
(S) FRE-T 3515, size 18" x 18"
(SO) FT35151836, size 18" x 36"



Concrete | Straw WB
09 Clay WB *
(S) FRE-T 3512, size 18" x 18"
(SO) FT35121836, size 18" x 36"



Concrete | Briney Grey WG
29 Moon Rock WG *
(S) FRE-T 3518, size 18" x 18"
(SO) FT35181836, size 18" x 36"



Concrete | Fallow CB
80 Fawn CB *
(S) FRE-T 3513, size 18" x 18"
(SO) FT35131836, size 18" x 36"



Concrete | North Sea Grey WG
48 Grey WG *
(S) FRE-T 3516, size 18" x 18"
(SO) FT35161836, size 18" x 36"



Concrete | Slate Grey CG
20 Charcoal WG *
(S) FRE-T 3517, size 18" x 18"
(SO) FT35171836, size 18" x 36"



Concrete | Russet WB
45 Sandalwood WB *
(S) FRE-T 3514, size 18" x 18"
(SO) FT35141836, size 18" x 36"



Concrete | Charcoal B
40 Black B *
(S) FRE-T 3519, size 18" x 18"
(SO) FT35191836, size 18" x 36"



Travertine | White W
27 Mist WG *
(S) FRE-T 5122, size 18" x 18"
(SO) Not Applicable



Travertine | Dapple Grey WB
195 Ash WG *
(S) FRE-T 5123, size 18" x 18"
(SO) Not Applicable

* Suggested Tarkett colors for finishing borders (wall base). For our complete color offering, reference color guide in back.

Sizes available: (S) = Standard, (SO) = Special Order



Travertine | Cream WB
129 Silk WB ★
(S) FRE-T 5121, size 18" x 18"
(SO) Not Applicable



Travertine | Walnut WB
45 Sandalwood WB ★
(S) FRE-T 5124, size 18" x 18"
(SO) Not Applicable



Linear Travertine | Cream W
50 White W ★
(S) FRE-T 5154, size 12" x 24"
(SO) FT51542424, size 24" x 24"



Linear Travertine | Roman Classic WB
22 Pearl CB ★
(S) FRE-T 5155, size 12" x 24"
(SO) FT51552424, size 24" x 24"



Linear Travertine | Nuez CB
121 Cement CB ★
(S) FRE-T 5156, size 12" x 24"
(SO) FT51562424, size 24" x 24"



MetaStone | Spar
283 Toast ★
(S) FRE-T 4111, size 12" x 24"
(SO) FT41112424, size 24" x 24"



MetaStone | Zinc
48 Grey WG ★
(S) FRE-T 4114, size 12" x 24"
(SO) FT41142424, size 24" x 24"



MetaStone | Ferro
48 Grey WB ★
(S) FRE-T 4115, size 12" x 24"
(SO) FT41152424, size 24" x 24"



MetaStone | Alchemy CB
283 Toast ★
(S) FRE-T 4113, size 12" x 24"
(SO) FT41132424, size 24" x 24"



MetaStone | Copper
TA7 Rusty Nail WB ★
(S) FRE-T 4112, size 12" x 24"
(SO) FT41122424, size 24" x 24"



Color Carrier | Yellow
TA1 Tannery WB ★
(S) FRE-T 5125, size 18" x 18"
(SO) FT51251836, size 18" x 36"



Color Carrier | Beige WB
461 Wicker WB ★
(S) FRE-T 5132, size 18" x 18"
(SO) FT51321836, size 18" x 36"



Color Carrier | Orange
113 Chestnutty ★
(S) FRE-T 5133, size 18" x 18"
(SO) FT51331836, size 18" x 36"



Color Carrier | Copper
149 Milk Chocolate ★
(S) FRE-T 5129, size 18" x 18"
(SO) FT51291836, size 18" x 36"

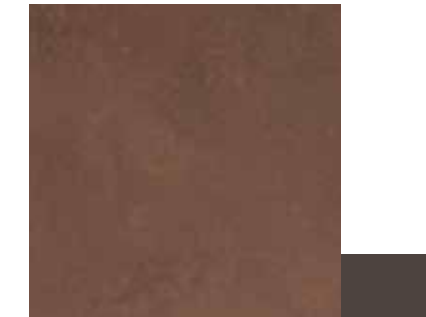

Color Carrier | Brown
284 Ganache ★
(S) FRE-T 5130, size 18" x 18"
(SO) FT51301836, size 18" x 36"



Color Carrier | Red
163 Salsa ★
(S) FRE-T 5134, size 18" x 18"
(SO) FT51341836, size 18" x 36"



Color Carrier | Violet
162 Sovereign ★
(S) FRE-T 5131, size 18" x 18"
(SO) FT51311836, size 18" x 36"



Color Carrier | Green
TB2 Boxwood ★
(S) FRE-T 5126, size 18" x 18"
(SO) FT51261836, size 18" x 36"



Color Carrier | Blue
TH2 Blue Intensity ★
(S) FRE-T 5128, size 18" x 18"
(SO) FT51281836, size 18" x 36"



Color Carrier | Grey Teal
41 Sea Breeze ★
(S) FRE-T 5127, size 18" x 18"
(SO) FT51271836, size 18" x 36"

* Suggested Tarkett colors for finishing borders (wall base). For our complete color offering, reference color guide in back.

Sizes available: (S) = Standard, (SO) = Special Order



I.D. Freedom™ Woods

LUXURY VINYL TILE

Look natural.

Since real already existed, we started there—tweaking and twisting it to our liking. The end result: I.D. Freedom™ Woods. See wider-than-natural grains in our oak. Experience pine that's been blanched or bronzed. Our luxury planks feature beautiful, natural woods—just with more of a story behind them. And some interesting options ahead.



Eastern Elm | Cornell | 76 Cinnamon ★
(S) FRE-P 7510, size 4" x 36" | (SO) FP7510636, size 6" x 36"



Native Pine | Grand Sorrel | TA2 Saddlebrook WB ★
(S) FRE-P 5131, size 6" x 48" | (SO) FP5131636, size 6" x 36"

thickness = .125" (3.18 mm)
adhesives pg. 196



Eastern Elm | Noce | 101 Seaweed ★
(S) FRE-P 7512, size 4" x 36" | (SO) FP7512636, size 6" x 36"



Seasoned Oak | Falcon | 284 Ganache ★
(S) FRE-P 4696, size 6" x 48" | (SO) FP4696448, size 4" x 48"



White Oak Classic | Honey | TA2 Saddlebrook WB ★
(S) FRE-P 2816, size 4" x 36" | (SO) FP2816448, size 4" x 48"



American Cherry | Natural | TA7 Rusty Nail WB ★
(S) FRE-P 7511, size 4" x 36" | (SO) FP7511648, size 6" x 48"



New Walnut | Castano | 76 Cinnamon ★
(S) FRE-P 5172, size 4" x 36" | (SO) FP5172448, size 4" x 48"



American Cherry | Heritage | 132 Espresso ★
(S) FRE-P 1233, size 4" x 36" | (SO) FP1233648, size 6" x 48"



New Walnut | Sumatran | 284 Ganache ★
(S) FRE-P 5173, size 4" x 36" | (SO) FP5173448, size 4" x 48"



White Oak Classic | Bourbon | 132 Espresso ★
(S) FRE-P 2815, size 4" x 36" | (SO) FP2815448, size 4" x 48"



Fruitwood | Umber | 47 Brown ★
(S) FRE-P 5163, size 4" x 36" | (SO) FP5163448, size 4" x 48"

★ Suggested Tarkett colors for finishing borders (wall base). For our complete color offering, reference color guide in back.

Sizes available: (S) = Standard, (SO) = Special Order



Koa | Natural | 284 Ganache *
(S) FRE-P 4698, size 4" x 36" | (SO) FP4698448, size 4" x 48"



Craft Maple | Pale | 130 Sisal *
(S) FRE-P 0512, size 4" x 36" | (SO) FP0512648, size 6" x 48"



Craft Maple | Cognac | 76 Cinnamon *
(S) FRE-P 0514, size 4" x 36" | (SO) FP0514648, size 6" x 48"



New Walnut | Natural | 130 Sisal *
(S) FRE-P 5174, size 4" x 36" | (SO) FP5174448, size 4" x 48"



Craft Maple | Bitter Brown | 47 Brown *
(S) FRE-P 0515, size 4" x 36" | (SO) FP0515648, size 6" x 48"



Fruitwood | Apple | 112 Oakley *
(S) FRE-P 5162, size 4" x 36" | (SO) FP5162448, size 4" x 48"



White Oak Classic | Espresso | 47 Brown *
(S) FRE-P 2817, size 4" x 36" | (SO) FP2817448, size 4" x 48"



White Oak Classic | Ginger | 112 Oakley *
(S) FRE-P 0814, size 4" x 36" | (SO) FP0814448, size 4" x 48"



Lumin Maple | Natural WB | 129 Silk *
(S) FRE-P 4681, size 4" x 36" | (SO) FP4681448, size 4" x 48"



Seasoned Oak | Brined WB | 129 Silk WB *
(S) FRE-P 4692, size 6" x 48" | (SO) FP4692448, size 4" x 48"



Seasoned Oak | Barrel | 112 Oakley *
(S) FRE-P 4697, size 6" x 48" | (SO) FP4697448, size 4" x 48"



Native Pine | Saratoga WB | 09 Clay WB *
(S) FRE-P 5135, size 6" x 48" | (SO) FP5135636, size 6" x 36"



Seasoned Oak | Scout | 101 Seaweed *
(S) FRE-P 4694, size 6" x 48" | (SO) FP4694448, size 4" x 48"



Seasoned Oak | Warm Silver WB | 461 Wicker WB *
(S) FRE-P 4693, size 6" x 48" | (SO) FP4693448, size 4" x 48"



Native Pine | Blanched Grey WG | 32 Pebble WG *
(S) FRE-P 5134, size 6" x 48" | (SO) FP5134636, size 6" x 36"



Native Pine | Arcadia | 101 Seaweed *
(S) FRE-P 5136, size 6" x 48" | (SO) FP5136636, size 6" x 36"



Seasoned Oak | Peppercorn B | 44 Dark Brown B *
(S) FRE-P 4695, size 6" x 48" | (SO) FP4695448, size 4" x 48"



Native Pine | Bronze | 45 Sandalwood WB *
(S) FRE-P 5137, size 4" x 36" | (SO) FP5137636, size 6" x 36"



Eastern Elm | Ginger | 45 Sandalwood WB *
(S) FRE-P 7480, size 4" x 36" | (SO) FP7480636, size 6" x 36"



Lumin Maple | Amber WB | 112 Oakley *
(S) FRE-P 4679, size 4" x 36" | (SO) FP4679448, size 4" x 48"

Sizes available: (S) = Standard, (SO) = Special Order * Suggested Tarkett colors for finishing borders (wall base). For our complete color offering, reference color guide in back.



I.D. Principle

Luxury Resilient Flooring

Solutions
for enduring
design and
performance.

This straightforward collection of designer woods will quickly update any space, while protecting your bottom line. We've developed new, contemporary designs based on our top-selling colors to ensure an enriching environment for every application. I.D. Principle's glue-down planks can be quickly installed in a variety of creative layouts, and their long-lasting performance will keep maintenance costs low throughout the life of the floor.



thickness = .125" (3.18 mm)
adhesives pg. 196



Loft Oak
0800748



Maritime Oak
0801748



Grange Oak
0802748



Oiled Walnut
0808748



Chalkhill
0807748



American Cherry
0803748



Hewn Chestnut
0805748



Red Star Alder
0806748



Mid-Modern Oak
0809748



Wild Maple
0804748

Sizes available: (S) = Standard, (SO) = Special Order



Transcend™ SureSet™

Luxury Resilient Flooring

**Engineered
for adversity.**

Transcend™ SureSet™ installs quickly, absorbs sound, and doesn't mind high-moisture subfloors. And that's just the backing. With a pre-applied adhesive that's easily repositioned, a sculpted wave technology that directs moisture and sound, and a Tritonite®-reinforced polyurethane that stands up to heavy traffic, this dimensionally stable solution forgives mishaps at every stage of the project, so it can keep looking beautiful for years to come.



thickness = .125" (3.18 mm)
adhesives pg. 196



CT4291 | Café
270263000



DM4641 | Pearl
270263001



CC110 | Surf
270261000



CC111 | Greystone
270261001



CC112 | Sand
270261002



B0801 | Lion
270262007



FM303 | Acer
270262006



C0331 | Burren
270260004



HM106 | Fumed
270260003



LAP101 | Dark Natural
270260006



LAP108 | Tea Toned
270260007



LAP109 | Ash Grey
270260008

Sizes available: (S) = Standard, (SO) = Special Order



RP431 | Brindle Grey
270260005



VO101 | Sanded Natural
270260000



VO104 | Enzo
270260001



VO105 | Moorland
270260002



NR530 | Ginger
270262008



NR531 | Scotch
270262009



PS510 | Praline
270262004



PS511 | Natural
270262005



SH100 | Meadow
270262000



SH101 | Auburn Royale
270262001

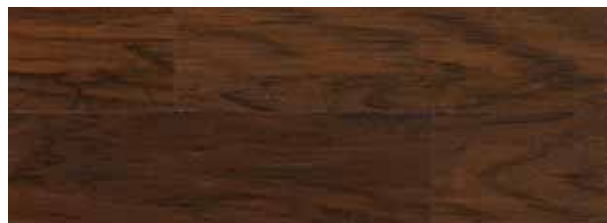

SH103 | Nutmeg
207262002



LP393 | Umber
270262003

Sizes available: (S) = Standard, (SO) = Special Order

Vinyl

Want every sheet, plank, tile, pattern, grain, texture and color to provide optimal interaction within a space? We can make that happen. We've designed all our iQ™, Luxury Tile, Accent™ Performa and other vinyl flooring collections to coordinate with each other, helping to connect spaces and the people who gather in them.

89

iQ™ Difference

102

Aria™

116

Performa™

90

iQ™ Optima®

104

Standard Plus®

118

Cortina Grande® – SVT

94

iQ™ Granit™

106

Accent® Flourish

122

Color Essence™ – VET

97

iQ™ Granit™ Micro

110

Accent® Woods

126

Azterra™ – VET

98

iQ™ Natural™

114

Accent® Concrete

128

Tarkett VCT

100

Melodia™

114

Accent® Zen
Accent® Tisse

Design. Aesthetics. Technology.

Is it possible to have too many design options? We don't think so. That's why our portfolio of vinyl flooring products is one of the most extensive in the industry—from budget-conscious solutions to highly engineered works of art.

Our homogeneous lines are available in both tile and sheet and include a UV-cured polyurethane (PUR) to deliver greater durability and easier maintenance. Meaning less water and cleaning products throughout a more than 20-year lifespan.

Taking convenience a step further, our iQ™ line promises no waxing. Ever.

Our heterogeneous product families provide more design opportunities than ever before. These low-maintenance, hygienic solutions drive value for a variety of applications—without sacrificing style.





Doctor
Radomski



iQ™ DIFFERENCE

- One consistent construction throughout the entire depth of the product allows it to be easily and continually restored to its original beauty
- Our uniquely resilient design provides superior resistance to wear, abrasion and stain beyond the typical surface coating
- Quality raw materials and our innovative product structure greatly extend the lifetime performance and beauty of our flooring

iQ MAINTENANCE

- No floor finish for life
- No protective chemicals, wax or polish required
- Fewer surface contaminants allow for more effective infection control
- Requires less water and chemical usage, and reduces discharge into waste water system

iQ SUSTAINABILITY

- Contains 25% recycled content as part of our ReStart® Reclamation Program
- FloorScore® certified, it reduces VOC emissions for better air quality
- Asthma and Allergy certified

iQ SAVINGS

- Eliminating wax and polish saves up to 30% of lifetime maintenance costs
- Provides lowest cleaning and maintenance life-cycle costs of any resilient flooring



Consider how a pencil works. As the pencil wears down or if the lead snaps, you simply sharpen that pencil to restore to new. The iQ technology performs in a similar manner. If a scratch or scuff is noticed, simply dry buff the product to restore it to new. No wax, no finish, no chemical strippers for life!

The photo to the left features one half of a scratched iQ floor tile (*left*) and the same tile buffed to remove the scratches (*right*).

iQ™ Optima®

HOMOGENEOUS SHEET AND TILE FLOORING

Take it in stride.

Inspired by the organic shifts and patterns created by nature, the new iQ Optima line of homogeneous sheet and tile draws from the soft, subtle strides found in natural stone or bark. Its multi-tonal aesthetic brings depth, dimension and warmth to commercial spaces. This is the iQ Optima you've known and loved, only better!



260 Sharktale WG
Solid Weld Rod 1287839
Multicolor 1290365
32 Pebble WG *



261 Kettle Black WG
Solid Weld Rod 1287534
Multicolor 1290366
TA4 Gateway WG *



262 Angel Kiss WG
Solid Weld Rod 1287279
Multicolor 1290151
460 Cotton W *



263 Outland Trails CB
Solid Weld Rod 1294083
Multicolor 1290174
TA8 Welsh Castle CB *



264 Spartan Helmet CB
Solid Weld Rod 1287447
Multicolor 1290173
283 Toast CB *



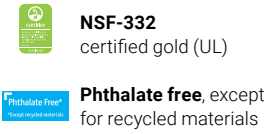
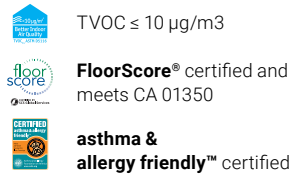

roll width = 6'6" nominal (2m)
roll length = 82'7" nominal (25 m)
thickness = .080" nominal (2 mm)

tile sizes =
12" x 12" nominal (305 mm x 305 mm)
24" x 24" nominal (610 mm x 610 mm)
12" x 24" nominal (305 mm x 610 mm)

Acoustiflor® options available. pg. 153
adhesives pg. 196



886 Beluga W
Solid Weld Rod 1291609
Multicolor 1290049
TB3 Dover CG *

202 Greyed Opal CG
Solid Weld Rod 1287837
Multicolor 1290356
21 Platinum CG *

850 Flan
Solid Weld Rod 1287041
Multicolor 1290045
129 Silk WB *

829 Peach Sorbet WB
Solid Weld Rod 1291342
Multicolor 1290040
79 Bone White W *

825 Caramel Infusion WB
Solid Weld Rod 1291203
Multicolor 1290024
461 Wicker WB *

259 Ruby Firestone
Solid Weld Rod 1287441
Multicolor 1290331
TB6 Flame *



856 Morning Sky
Solid Weld Rod 1288905
Multicolor 1290051
84 Blue Jeans *

847 Periwinkle WB
Solid Weld Rod 1287513
Multicolor 1290111
84 Blue Jeans *

821 Frothy Latte CB
Solid Weld Rod 1291821
Multicolor 1290159
31 Seafarer CB *

872 Silver Bell CG
Solid Weld Rod 1287523
Multicolor 1290121
23 Vapor Grey CG *

248 French Pastry CB
Solid Weld Rod 1287233
Multicolor 1290343
195 Ash WG *

875 Bedrock WG
Solid Weld Rod 1287526
Multicolor 1290124
20 Charcoal WG *



831 Hot Ginger
Solid Weld Rod 1287059
Multicolor 1290335
130 Sisal *

824 Yellow Mustard
Solid Weld Rod 1287827
Multicolor 1290334
TG7 Canary *

826 Goldenrod
Solid Weld Rod 1287504
Multicolor 1290102
130 Sisal *

257 Tiger Glow
Solid Weld Rod 1287834
Multicolor 1290352
TG8 Spicy Chip *

255 Mountain Blush
Solid Weld Rod 1287823
Multicolor 1290350
162 Sovereign *

258 Monarch Flying
Solid Weld Rod 1287472
Multicolor 1290353
TG8 Spicy Chip *



246 Egyptian Scrolls
Solid Weld Rod 1292319
Multicolor 1290290
280 Shoreline CB *

861 Clover Leaf
Solid Weld Rod 1287592
Multicolor 1290337
151 Iguana *

857 Popiu Bay
Solid Weld Rod 1287841
Multicolor 1290336
84 Blue Jeans *

245 Foggy Shores WG
Solid Weld Rod 1287279
Multicolor 1290085
24 Grey Haze WG *

244 Darkened Oasis B
Solid Weld Rod 1287835
Multicolor 1290124
63 Burnt Umber B *

849 Blue Satin
Solid Weld Rod 1287515
Multicolor 1290113
18 Navy Blue *



860 Malt WB
Solid Weld Rod 1287039
Multicolor 1290066
280 Shoreline WB *

256 Violet Hill
Solid Weld Rod 1287829
Multicolor 1290351
162 Sovereign *

820 Coffee Shoppe WB
Solid Weld Rod 1287005
Multicolor 1290099
49 Beige WB *

254 Lucky Clover
Solid Weld Rod 1287352
Multicolor 1290349
151 Iguana *

900 Old Bark
Solid Weld Rod 1287013
Multicolor 1290089
167 Fudge *

253 Greenhouse Lane
Solid Weld Rod 1287826
Multicolor 1290348
59 Heather Green *



243 Sabled Street WG
Solid Weld Rod 1294727
Multicolor 1290341
20 Charcoal WG *

242 Ebony Ash WG
Solid Weld Rod 1287006
Multicolor 1290340
48 Grey WG *

209 Glowing Sand Dune CB
Solid Weld Rod 1287223
Multicolor 1290363
121 Cement CB *

208 Desert Flower CB
Solid Weld Rod 1287204
Multicolor 1290362
31 Zephyr CB *

207 Prairie Dancing
Solid Weld Rod 1287830
Multicolor 1290361
TA8 Welsh Castle CB *

845 Stroke of Midnight B
Solid Weld Rod 1291845
Multicolor 1290034
40 Black B *



251 Spencer's Eyes
Solid Weld Rod 1287825
Multicolor 1290346
72 Harbour *

252 Putting Green
Solid Weld Rod 1287833
Multicolor 1290347
59 Heather Green *

250 Rushing Waters
Solid Weld Rod 1287824
Multicolor 1290345
92 Blue Lagoon *

899 Flannel Blanket CB
Solid Weld Rod 1287447
Multicolor 1290088
80 Fawn *

873 Koala Bear CG
Solid Weld Rod 1287524
Multicolor 1290122
469 Mystify CG *

862 Raw Ivory CB
Solid Weld Rod 1291862
Multicolor 1290025
68 White Sand W *



897 Slate WG
Solid Weld Rod 1287170
Multicolor 1290203
32 Pebble WG *

836 Turf
Solid Weld Rod 1287040
Multicolor 1290078
TH1 Glenhaven *

206 Hazy Valley CG
Solid Weld Rod 1287828
Multicolor 1290360
469 Mystify CG *

205 Summer Moon W
Solid Weld Rod 1287838
Multicolor 1290359
460 Cotton W *

898 Heavy Cream WG
Solid Weld Rod 1287333
Multicolor 1290339
TA4 Gateway WG *

204 Cobalt Smoke WG
Solid Weld Rod 1287832
Multicolor 1290358
48 Grey WG *

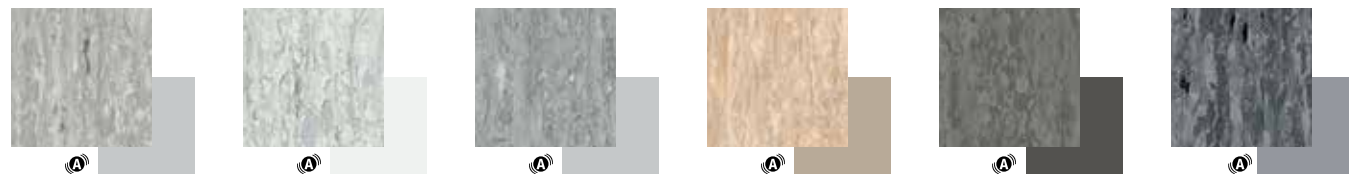

864 Concrete Slab CG
Solid Weld Rod 1287412
Multicolor 1290029
21 Platinum CG *

871 Arctic Winter W
Solid Weld Rod 1287522
Multicolor 1290120
50 White W *

853 Thunderhead CG
Solid Weld Rod 1292388
Multicolor 1290022
21 Platinum CG *

247 Almond Cream WB
Solid Weld Rod 1291615
Multicolor 1290342
49 Beige WB *

874 Hardwired WG
Solid Weld Rod 1287840
Multicolor 1290338
20 Charcoal WG *

866 Sidewalk CG
Solid Weld Rod 1287842
Multicolor 1290026
38 Pewter CG *

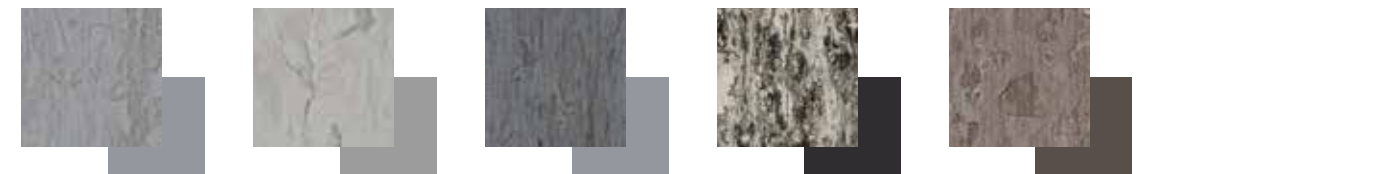

200 Cathedral Wall CG
Solid Weld Rod 1292160
Multicolor 1290354
38 Pewter CG *

203 Infused Ash CG
Solid Weld Rod 1287831
Multicolor 1290357
TA5 Colonial Grey CG *

201 Chimney Sweep CG
Solid Weld Rod 1287836
Multicolor 1290355
38 Pewter CG *

951 Salt N Pep B
Solid Weld Rod 1287170
Multicolor 1290364
63 Burnt Umber B *

249 Forest Thicket WB
Solid Weld Rod 1287458
Multicolor 1290344
47 Brown *

We've identified Color Foundations neutrals in the following way: WB (warm beige), CB (cool beige), WG (warm grey), CG (cool grey), B (black), W (white).

Color Foundations™ is our commitment to always have representation across six key neutral palettes.

*Suggested Tarkett colors for finishing borders (wall base). For our complete color offering, reference color guide in back.

The Solid and Multicolor Weld Rods listed are coordinating recommendations. Other color weld rods can be used for a variety of visual effects.

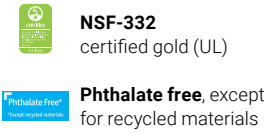
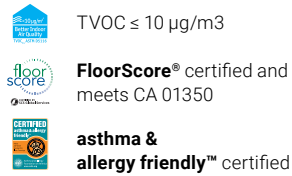

roll width = 6'6" nominal (2m)
roll length = 82'7" nominal (25 m)
thickness = see individual patterns for availability

tile sizes =
 12" x 12" nominal (305 mm x 305 mm)
 24" x 24" nominal (610 mm x 610 mm)
 12" x 24" nominal (305 mm x 610 mm)

Coordinating Granit Safe-T available.
 Coordinating iQ Granit SD or iQ Toro SC available.

iQ toro sc pg. 156
 iQ granit sd pg. 157
adhesives pg. 196



iQ™ Granit™

HOMOGENEOUS SHEET AND TILE FLOORING

Step it up.

iQ™ Granit™. Tough, you can't-beat-me construction that'll last the life of the floor without waxing or stripping. Beautiful, nondirectional stone patterns in a range of colors. Plus, homogeneous composition. Which means all that good stuff runs through the entire product, and doesn't just stop at the surface.

iQ Granit is also available in slip-resistant Granit Safe-T and static-dissipative iQ Granit SD.



453 Narwhal WB
 Solid Weld Rod 1287324
 Multicolor 1290292
 11 Canvas WB *

445 Vintage WG
 Solid Weld Rod 1287531
 Multicolor 1290142
 195 Ash WG *



770 Soft Fleece WB
 Solid Weld Rod 1288255
 Multicolor 1290036
 11 Canvas WB *

463 Pebblestone CB
 Solid Weld Rod 1287427
 Multicolor 1290248
 TA3 Castaway CB *



421 Sandlot WB
 Solid Weld Rod 1291352
 Multicolor 1290033
 12 Hard Rock WB *

419 Portland Grey CB
 Solid Weld Rod 1287341
 Multicolor 1290061
 80 Fawn CB *



434 Latte CB
 Solid Weld Rod 1287292
 Multicolor 1290069
 80 Fawn CB *

410 Queens Ferry WB
 Solid Weld Rod 1287685
 Multicolor 1290329
 49 Beige WB *

The Solid and Multicolor Weld Rods listed are coordinating recommendations. Other color weld rods can be used for a variety of visual effects.

* Suggested Tarkett colors for finishing borders (wall base). For our complete color offering, reference color guide in back.

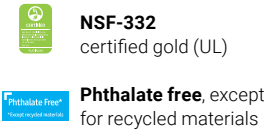
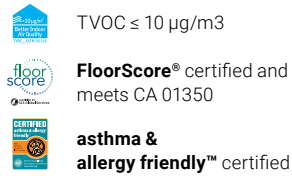

roll width = 6'6" nominal (2m)
roll length = 82'7" nominal (25 m)
thickness = see individual patterns for availability

tile sizes =
12" x 12" nominal (305 mm x 305 mm)
24" x 24" nominal (610 mm x 610 mm)
12" x 24" nominal (305 mm x 610 mm)

Coordinating Granit Safe-T available.
Coordinating iQ Granit SD or iQ Toro SC available.

iQ toro sc pg. 156
iQ granit sd pg. 157
adhesives pg. 196



772 Sea Stone Solid Weld Rod 1291772 Multicolor 1290039 286 Fortune Cookie WB ★
428 Acorn WB Solid Weld Rod 1287407 Multicolor 1290023 130 Sisal ★
372 Grand Canyon WB Solid Weld Rod 1292372 Multicolor 1290031 286 Fortune Cookie WB ★
409 Camellia WB Solid Weld Rod 1287686 Multicolor 1290330 461 Wicker WB ★
404 Glendale CG Solid Weld Rod 1287617 Multicolor 1290214 TB3 Dover Grey CG ★
460 Slate Rock CG Solid Weld Rod 1287446 Multicolor 1290151 TA5 Colonial Grey CG ★



782 Mystic Grey CG Solid Weld Rod 1294680 Multicolor 1290043 TB3 Dover Grey CG ★
382 Yoga CG Solid Weld Rod 1292811 Multicolor 1290028 38 Pewter CG ★
446 Taft WG Solid Weld Rod 1287290 Multicolor 1290185 32 Pebble WG ★
461 Nightshade CG Solid Weld Rod 1287606 Multicolor 1290168 469 Mystify CG ★
383 Homing Pigeon CG Solid Weld Rod 1292383 Multicolor 1290021 TA5 Colonial Grey CG ★
447 Huntoon WG Solid Weld Rod 1287170 Multicolor 1290086 32 Pebble WG ★



449 Mercury CB Solid Weld Rod 1287537 Multicolor 1290144 TA8 Welsh Castle CB ★
408 Wintercrest Solid Weld Rod 1287678 Multicolor 1290321 591 Sleet ★
432 Pixie Solid Weld Rod 1287370 Multicolor 1290052 139 Glacier ★
777 Blue Veranda Solid Weld Rod 1291210 Multicolor 1290038 139 Glacier ★
749 Catalina Solid Weld Rod 1287509 Multicolor 1290107 192 Tidewater ★
379 Full Sail Solid Weld Rod 1292379 Multicolor 1290041 84 Blue Jeans ★



448 Sawyer Solid Weld Rod 1287677 Multicolor 1290319 72 Harbour ★
778 Nautical Mile Solid Weld Rod 1287681 Multicolor 1290324 465 Seafarer ★
751 Freesia Solid Weld Rod 1287036 Multicolor 1290070 285 Morning Light WB ★
417 Dahlia Solid Weld Rod 1287682 Multicolor 1290325 TB5 Sunspot ★
423 Semolian Solid Weld Rod 1287249 Multicolor 1290056 473 Butterscotch ★
418 Arancia Solid Weld Rod 1287683 Multicolor 1290326 273 Copper Penny ★

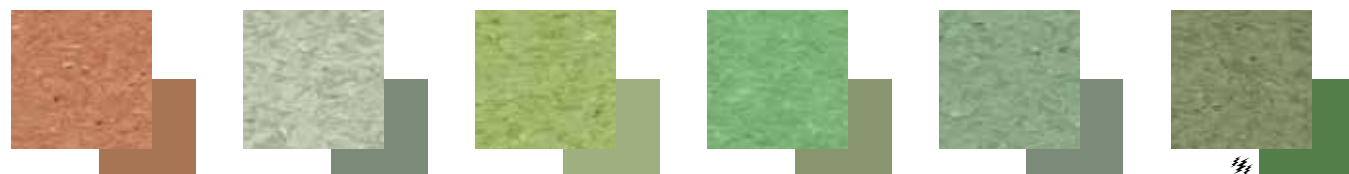

375 Hot Chocolate Solid Weld Rod 1292375 Multicolor 1290046 111 Honeycomb ★
407 Aloe Solid Weld Rod 1287679 Multicolor 1290322 289 Jaded ★
750 Bexley Solid Weld Rod 1287518 Multicolor 1290116 475 Marshland ★
406 Sage Solid Weld Rod 1287676 Multicolor 1290318 271 Seedling ★
426 Acadia Solid Weld Rod 1287332 Multicolor 1290059 289 Jaded ★
405 Vine Solid Weld Rod 1287588 Multicolor 1290328 467 Arugula ★



464 Creation Solid Weld Rod 1287673 Multicolor 1290314 147 South Seas ★
450 Azalea Solid Weld Rod 1287674 Multicolor 1290315 163 Salsa ★
411 Prim Rose Solid Weld Rod 1287687 Multicolor 1290331 294 Bigtop ★
416 Fallon Solid Weld Rod 1287684 Multicolor 1290327 166 Sienna ★
415 Woodruff CB Solid Weld Rod 1287680 Multicolor 1290323 283 Toast ★
451 Noble Solid Weld Rod 1287645 Multicolor 1290316 162 Sovereign ★

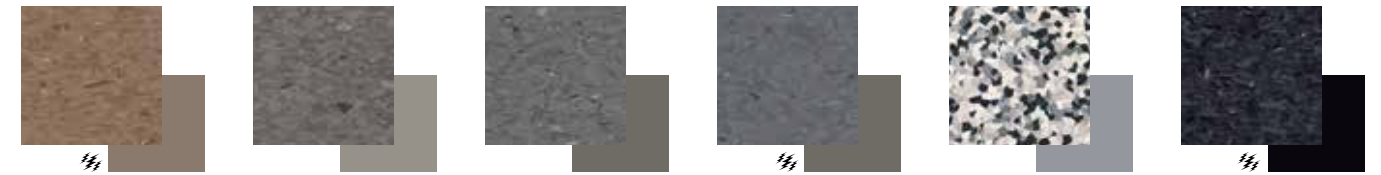

414 Filbert CB Solid Weld Rod 1287675 Multicolor 1290317 107 Neutrality ★
420 Stone Harbor WG Solid Weld Rod 1287333 Multicolor 1290050 32 Pebble WG ★
462 Midnight Storm WG Solid Weld Rod 1287491 Multicolor 1290320 48 Grey WG ★
435 Eclipse CG Solid Weld Rod 1288327 Multicolor 1290027 48 Grey WG ★
431 Mystic CG Solid Weld Rod 1287322 Multicolor 1290083 38 Pewter CG ★
384 After Midnight B Solid Weld Rod 1292384 Multicolor 1290035 40 Black B ★

iQ GRANIT™ MICRO



350 Sylar CG Solid Weld Rod 1287691 38 Pewter CG ★
351 Tempest CG Solid Weld Rod 1287692 TA5 Colonial Grey CG ★
352 Pebblebrook WG Solid Weld Rod 1287693 32 Pebble WG ★
353 Utopia CG Solid Weld Rod 1287694 TA5 Colonial Grey CG ★
354 Guster CB Solid Weld Rod 1287695 TA3 Castaway CB ★
355 Spano CB Solid Weld Rod 1287696 80 Fawn CB ★



356 Tusk WB Solid Weld Rod 1287697 11 Canvas WB ★
357 Concord WB Solid Weld Rod 1287698 05 Stone WB ★
358 Checotah WB Solid Weld Rod 1287699 12 Hard Rock WB ★
359 Lantana WB Solid Weld Rod 1287700 461 Wicker WB ★
360 Meadows Solid Weld Rod 1287701 289 Jaded ★
361 Scholti Solid Weld Rod 1287702 192 Tidewater ★

The Solid and Multicolor Weld Rods listed are coordinating recommendations. Other color weld rods can be used for a variety of visual effects.

* Suggested Tarkett colors for finishing borders (wall base). For our complete color offering, reference color guide in back.

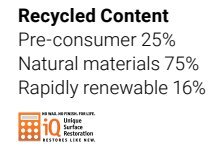
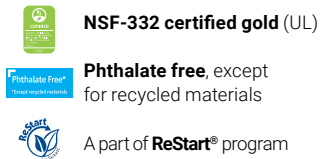
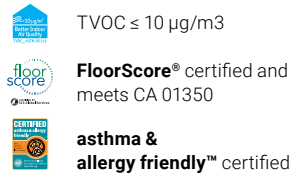

roll width = 6'6" nominal (2m)
roll length = 82'7" nominal (25m)

thickness = .080" nominal (2 mm)
adhesives pg. 196



iQ™ Natural™

HOMOGENEUS SHEET FLOORING

Unify.

We think you'll agree, the more you can achieve with a single product, the better. So we combined the durability of iQ construction with the beauty of Melodia™ 2.0 to create iQ Natural. With a revolutionary plasticizer made from 75% natural and 16% renewable resources, it's a natural choice for more earth-friendly design—without compromising style and strength.



282 Sesame Seed WB Solid Weld Rod 1296012 Multicolor 1297012 49 Beige WB *	283 Sand Dunes Solid Weld Rod 1296013 Multicolor 1297013 130 Sisal *	287 Daybreak Solid Weld Rod 1296017 Multicolor 1297017 01 Snow White W *	286 Orange Peel Solid Weld Rod 1296016 Multicolor 1297016 TG Snowbound W *	284 Light Molasses Solid Weld Rod 1296014 Multicolor 1297014 113 Chestnutty *	285 Poppy Solid Weld Rod 1296015 Multicolor 1297015 TB6 Flame *
276 Waterfall WB Solid Weld Rod 1296006 Multicolor 1297006 22 Pearl CB *	280 Pelican WG Solid Weld Rod 1296010 Multicolor 1297010 24 Grey Haze WG *	288 Marshland WB Solid Weld Rod 1296018 Multicolor 1297018 129 Silk WB *	281 Rye Seed WB Solid Weld Rod 1296011 Multicolor 1297011 461 Wicker WB *	277 Natural Terrain WB Solid Weld Rod 1296007 Multicolor 1297007 49 Beige WB *	278 Sea Otter CB Solid Weld Rod 1296008 Multicolor 1297008 283 Toast *
289 Canopy Solid Weld Rod 1296019 Multicolor 1297019 151 Iguana *	290 Prairie Solid Weld Rod 1296020 Multicolor 1297020 TH1 Glenhaven *	291 Ivy Solid Weld Rod 1296021 Multicolor 1297021 460 Cotton *	292 Bayside Solid Weld Rod 1296022 Multicolor 1297022 58 Windsor Blue *	293 Open Seas Solid Weld Rod 1296023 Multicolor 1297023 58 Windsor Blue *	294 Fresh Blueberry Solid Weld Rod 1296024 Multicolor 1297024 84 Blue Jeans *
271 Cirrus W Solid Weld Rod 1296002 Multicolor 1297002 460 Cotton W *	272 Stratus CG Solid Weld Rod 1296003 Multicolor 1297003 23 Vapor Grey *	273 Nimbus CG Solid Weld Rod 1296001 Multicolor 1297001 38 Pewter CG *	274 Shadow CG Solid Weld Rod 1296004 Multicolor 1297004 71 Storm Cloud CG *	279 Bayou Solid Weld Rod 1296009 Multicolor 1297009 47 Brown *	275 Nocturnal B Solid Weld Rod 1296005 Multicolor 1297005 40 Black B *

The Solid and Multicolor Weld Rods listed are coordinating recommendations. Other color weld rods can be used for a variety of visual effects.

* Suggested Tarkett colors for finishing borders (wall base). For our complete color offering, reference color guide in back.



FloorScore® certified and meets CA 01350



NSF-332 certified gold (UL)



A part of ReStart® program



TVOC ≤ 10 µg/m³



Phthalate free, except for recycled content

Recycled Content Pre-consumer 25%

roll width = 6'6" nominal (2m)

roll length = 75'9" nominal (25 m)

tile sizes =

12"x 12" nominal (305 mm x 305 mm)
24"x 24" nominal (610 mm x 610 mm)
12"x 24" nominal (305 mm x 610 mm)

thickness = .080" nominal (2 mm)

adhesives pg. 196

Coordinates with Aria 2.0

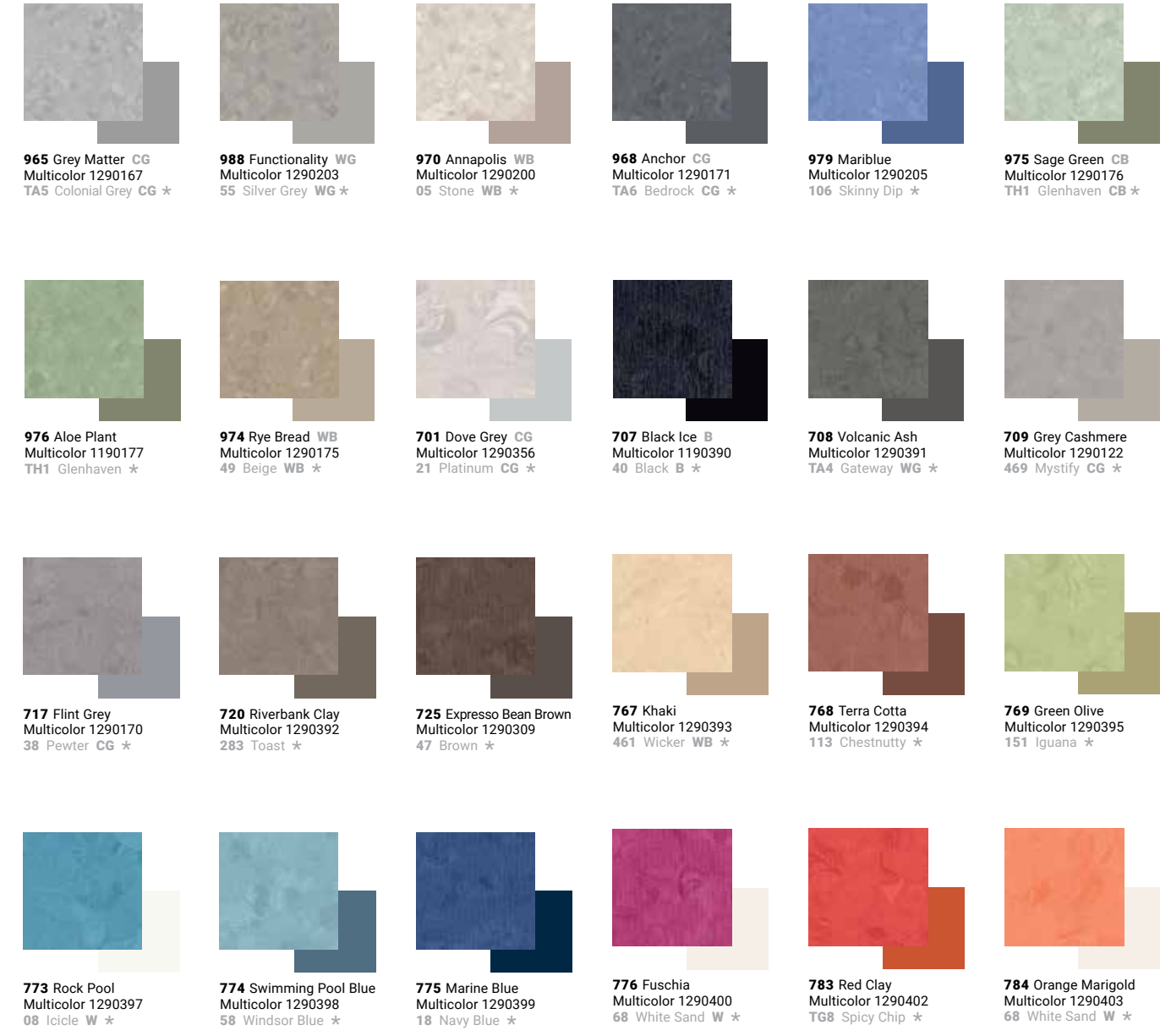
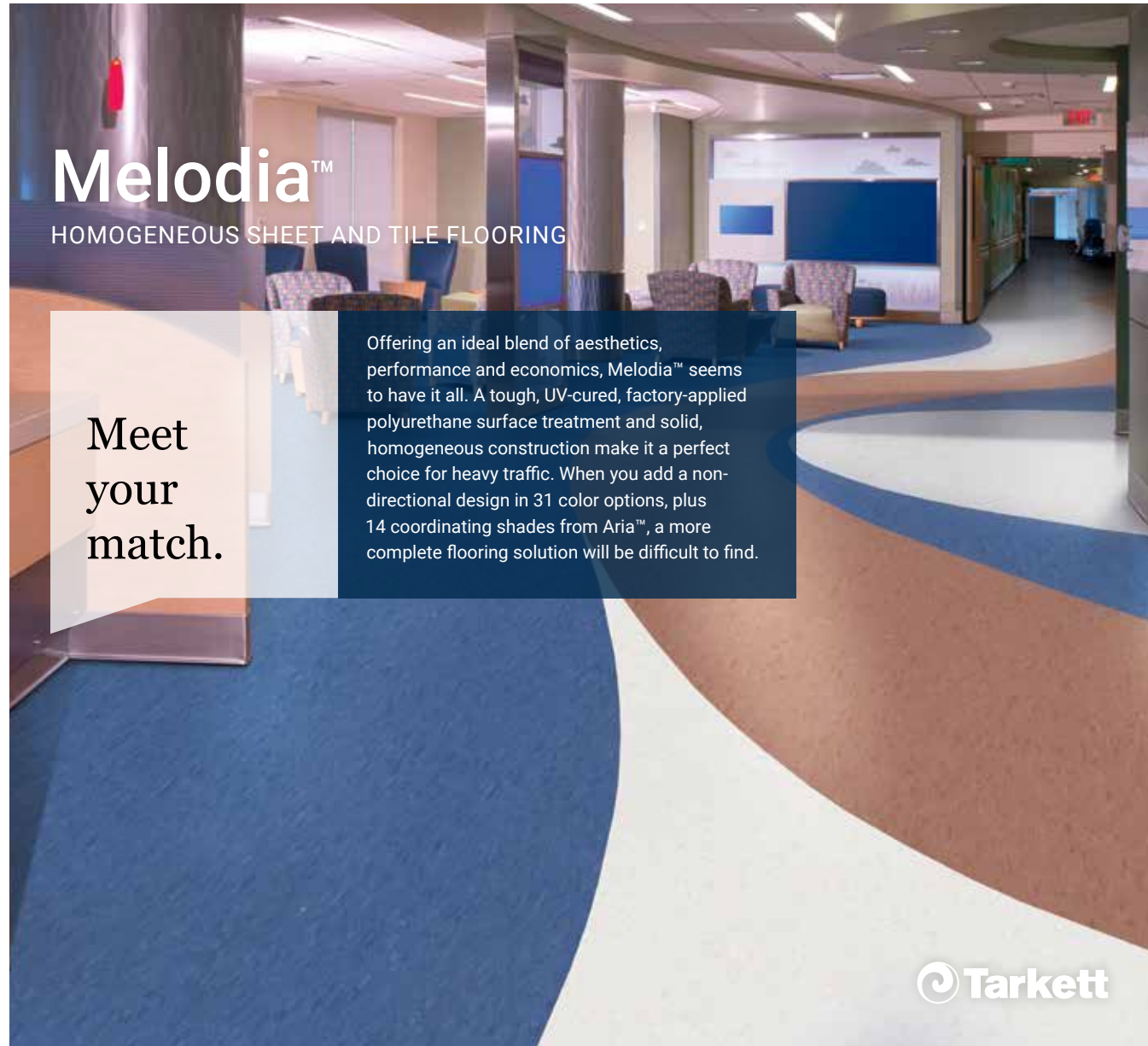

The Solid Weld Rods listed are coordinating recommendations. Other color weld rods can be used for a variety of visual effects.

* Suggested Tarkett colors for finishing borders (wall base). For our complete color offering, reference color guide in back.



FloorScore® certified and meets CA 01350

NSF-332 certified gold (UL)



A part of ReStart® program



TVOC ≤ 10 µg/m3



Phthalate free, except for recycled content

Recycled Content Pre-consumer 25%

roll width = 6'6" nominal (2m)

roll length = 75'9" nominal (25 m)

tile sizes =

12"x 12" nominal (305 mm x 305 mm)
24"x 24" nominal (610 mm x 610 mm)
12"x 24" nominal (305 mm x 610 mm)

thickness = .080" nominal (2 mm)

adhesives pg. 196

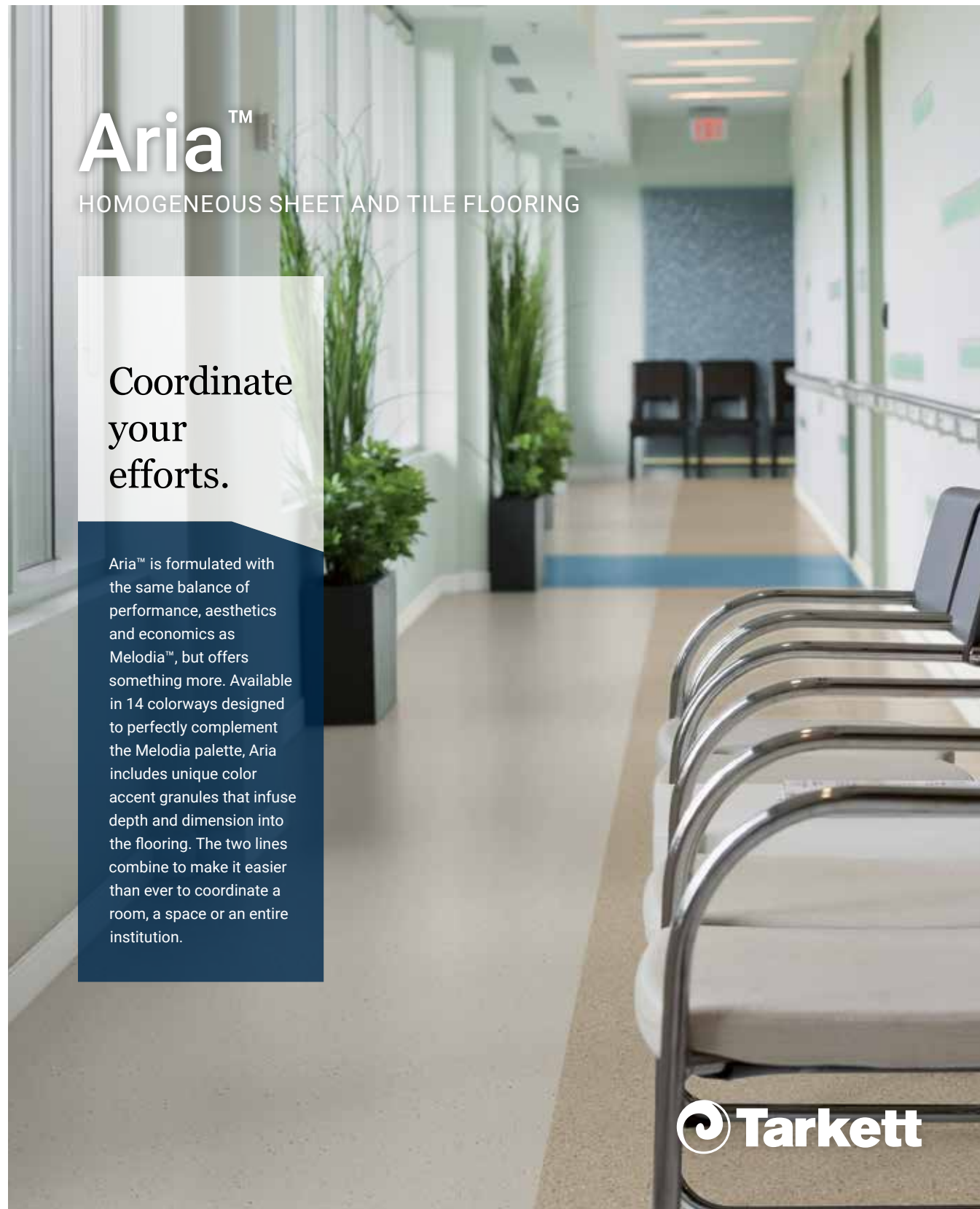











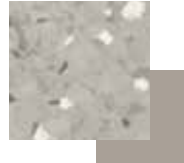

Aria™

HOMOGENEOUS SHEET AND TILE FLOORING

Coordinate your efforts.

Aria™ is formulated with the same balance of performance, aesthetics and economics as Melodia™, but offers something more. Available in 14 colorways designed to perfectly complement the Melodia palette, Aria includes unique color accent granules that infuse depth and dimension into the flooring. The two lines combine to make it easier than ever to coordinate a room, a space or an entire institution.



 658 Iced Tea WB Multicolor 1290159 11 Canvas WB *	 657 Cabana WB Multicolor 1290158 05 Stone WB *	 673 Urban Legend Multicolor 1290225 38 Pewter CG *	 655 Gypsy Moth CB Multicolor 1290156 121 Cement CB *	 652 Gravel CG Multicolor 1290153 TA5 Colonial Grey CG *	 659 Brown Sugar WB Multicolor 1290160 49 Beige WB *
 672 Diorite CG Multicolor 1290220 TB3 Dover CG *	 675 Quartzite WB Multicolor 1290229 460 Cotton W *	 640 Light Green Quartz Multicolor 1290383 460 Cotton W *	 600 Silver Fox Multicolor 1290377 55 Silver Grey WG *		
 066 Bird Egg Beige Solid Weld Rod 1287459 TA3 Castaway CG *	 064 Beach Stone Solid Weld Rod 1287459 38 Pewter CG *	 065 Fazed Grey Solid Weld Rod 1287880 23 Vapor Grey CG *	 068 Limestone Solid Weld Rod 1292393 05 Stone WB *		

From flooring to bases to transitions, these options were designed to coordinate perfectly. Eliminating guesswork and allowing you to design with ease.

The Solid Weld Rods listed are coordinating recommendations.

* Suggested Tarkett colors for finishing borders (wall base). For our complete color offering, reference color guide in back.

tile sizes
12"x12" (305mm x 305 mm)
12"x24" (305 mm x 610 mm)
24"x24" (610 mm x 610 mm)

roll = 6' 6" x 75' 9"
thickness = .080" (2 mm)
adhesives pg. 196



Standard Plus®

HOMOGENEOUS VINYL SHEET FLOORING

**Gentle design.
Tough construction.**

With the gently striated appearance of soft linen, Standard Plus offers a beautiful tone-on-tone palette in 14 colorways, all carefully selected to coordinate with the entire Tarkett portfolio. From education to workplace and beyond, Standard Plus combines durable performance with competitive pricing, all while delivering great design. Choose between homogeneous tile and sheet formats—both are phthalate free, FloorScore® Certified, and made with 25% pre-consumer recycled content.

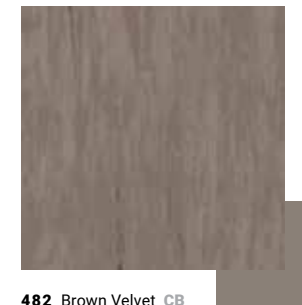

482 Brown Velvet CB
TA8 Welsh Castle CB ★
Weld Rod 1287373



485 Funnel Cake
129 Silk WB ★
Weld Rod 1287439



492 Surf
84 Blue Jeans ★
Weld Rod 1291210

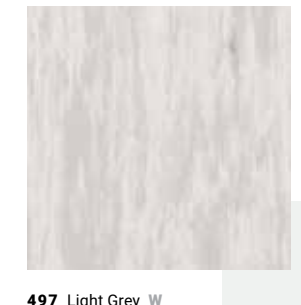

497 Light Grey W
50 White W ★
Weld Rod 1287338

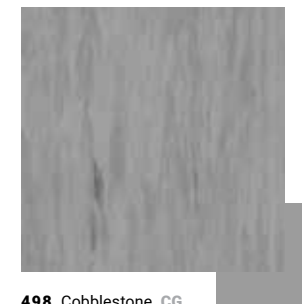

498 Cobblestone CG
TA5 Colonial Grey CG ★
Weld Rod 1287027



499 Cloudburst WG
48 Grey WG ★
Weld Rod 1287394

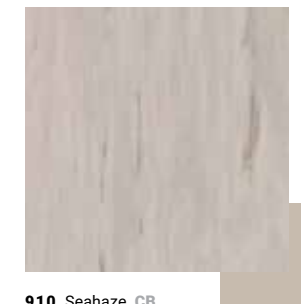

910 Seahaze CB
31 Zephyr CB ★
Weld Rod 1292319



911 Morning Dove
80 Fawn WB ★
Weld Rod 1287291



912 Sandlot
22 Pearl CB ★
Weld Rod 1287334

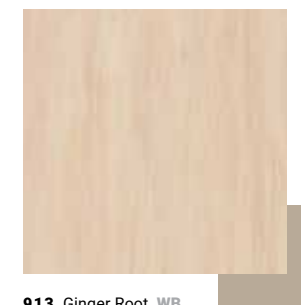

913 Ginger Root WB
49 Beige WB ★
Weld Rod 1287098

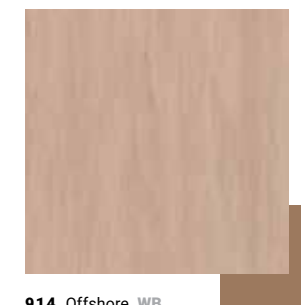

914 Offshore WB
45 Sandalwood WB ★
Weld Rod 1287597

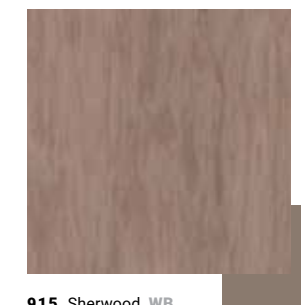

915 Sherwood WB
107 Neutrality WB ★
Weld Rod 1287380



923 Green Meadow
73 Palm Leaf ★
Weld Rod 1287450

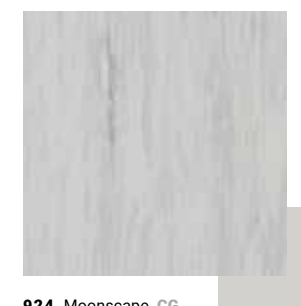

924 Moonscape CG
TB3 Dover Grey CG ★
Weld Rod 1287446

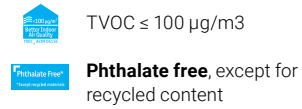
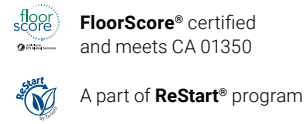

roll width = 6'6" nominal (2m)
roll length = 76' nominal (23 m)
thickness = .080" (2 mm)

adhesives pg. 196



Acczent® Flourish

HETEROGENEOUS SHEET FLOORING

Weave it all together.

Get the hygienic performance and low maintenance of heterogeneous vinyl sheet—but with the look and feel of LVT. Acczent Flourish is a collection of three textile-inspired designs, each with the feel of a softly woven linen. The three patterns are designed to coordinate and work together to add warmth and dimension to the space. Its 32mil wear layer remains tough under heavy traffic, and our UV-cured polyurethane reduces the need for polish and spray buffing.



Acczent Flourish. Weave it all together.

THRIVE

Start with this foundational pattern, typically seen in main walkways and corridors. Thrive delivers the soft look of a nonlinear weave, reminiscent of hand-fashioned textiles, and sets a soothing tone throughout the space.



INSPIRE

Building on the Thrive pattern, Inspire adds a subtle crisscrossing wave element that fades in and out of sight, hinting at an embellishment or an embroidered stitch. This added texture creates visual interest in highlighted spaces, such as room transitions or seating areas.



PROSPER

Using Thrive again as the base pattern, Prosper adds strands of rich color and a more heavily defined linear texture. By placing more visual weight on each stitch, Prosper carries greater depth and dimension, making it ideal for areas where more color contrast is desired.



THRIVE

INSPIRE

PROSPER



200 Affinity WB
Solid Weld Rod 1287402
09 Clay WB *



201 Solstice WB
Solid Weld Rod 1291821
TA1 Tannery WB *



400 Affinity WB
Solid Weld Rod 1292465
09 Clay WB *



401 Solstice WB
Solid Weld Rod 1294728
TA1 Tannery WB *



300 Affinity WB
Solid Weld Rod 1287012
09 Clay WB *



301 Solstice WB
Solid Weld Rod 1287501
TA1 Tannery WB *



202 Tranquility CB
Solid Weld Rod 1287402
TA3 Castaway CB *



209 Enrich CB
Solid Weld Rod 1287713
280 Shoreline *



402 Tranquility CB
Solid Weld Rod 1287178
TA3 Castaway CB *



409 Enrich CB
Solid Weld Rod 1287713
280 Shoreline *



302 Tranquility CB
Solid Weld Rod 1291839
TA3 Castaway CB *



309 Enrich CB
Solid Weld Rod 1287714
280 Shoreline *



207 Connection WG
Solid Weld Rod 1287290
27 Mist WG *



203 Kindred WG
Solid Weld Rod 1292770
24 Grey Haze WG *



407 Connection WG
Solid Weld Rod 1287290
27 Mist WG *



403 Kindred WG
Solid Weld Rod 1287290
24 Grey Haze WG *



307 Connection WG
Solid Weld Rod 1291215
27 Mist WG *



303 Kindred WG
Solid Weld Rod 1291215
24 Grey Haze WG *



204 Essence CB
Solid Weld Rod 1292771
80 Fawn CB *



206 Stability CG
Solid Weld Rod 1287183
TA6 Bedrock CG *



404 Essence CB
Solid Weld Rod 1287284
80 Fawn CB *



406 Stability CG
Solid Weld Rod 1287454
TA6 Bedrock CG *



304 Essence CB
Solid Weld Rod 1287497
80 Fawn CB *



306 Stability CG
Solid Weld Rod 1287548
TA6 Bedrock CG *



208 Reflection CG
Solid Weld Rod 1287374
TA5 Colonial Grey CG *



205 Serenade WG
Solid Weld Rod 1287457
32 Pebble WG *



408 Reflection CG
Solid Weld Rod 1287374
TA5 Colonial Grey CG *



405 Serenade WG
Solid Weld Rod 1287382
32 Pebble WG *



308 Reflection CG
Solid Weld Rod 1287278
TA5 Colonial Grey CG *



305 Serenade WG
Solid Weld Rod 1287457
32 Pebble WG *

* Suggested Tarkett colors for finishing borders (wall base). For our complete color offering, reference color guide in back.

Color Foundations™ is our commitment to always have representation across six key neutral palettes. We've identified Color Foundations neutrals in the following way: WB (warm beige), CB (cool beige), WG (warm grey), CG (cool grey), B (black), W (white).

Acczent®

HETEROGENEOUS SHEET FLOORING

Overachieve.

Smarter is always better, so we're sending the Acczent® Collection to the head of the class. The look of sophisticated hardwoods, stylish concrete and elegant tissé patterns, in easy-to-maintain vinyl. Now that's brilliant. With a durable UV-cured, factory applied polyurethane wear layer, the Acczent Collection is as tough as it is beautiful.

ACCENT® WOODS



29013 Allover Wood Black **CG** | Solid Weld Rod 1287548
 TA6 Bedrock **CG** *



29006 Long Modern Oak Black **B** | Solid Weld Rod 1287576
 44 Dark Brown **B** *



29011 Allover Wood Grege **WB** | Solid Weld Rod 1287437
 49 Beige **WB** *



29007 Long Modern Oak Brown | Solid Weld Rod 1287013
 TB1 Peppercorn *



29012 Allover Wood Brown **WB** | Solid Weld Rod 1287492
 45 Sandalwood **WB** *



30002 Beech Light **WB** | Solid Weld Rod 1294315
 130 Sisal *



29005 Long Modern Oak White **W** | Solid Weld Rod 1289538
 TA3 Castaway **CB** *



81003 Beech Medium **WB** | Solid Weld Rod 1287430
 TA7 Rusty Nail *



29010 Long Modern Oak Natural **WG** | Solid Weld Rod 1287153
 130 Sisal *



81004 Beech Dark **WB** | Solid Weld Rod 1292207
 TA7 Rusty Nail *



29009 Long Modern Oak Natural Brown | Solid Weld Rod 1287664
 TA2 Saddlebrook **WB** *



30007 Walnut Natural **WB** | Solid Weld Rod 1287287
 TA2 Saddlebrook **WB** *



30008 Walnut Dark | Solid Weld Rod 1287663
 47 Brown *



30005 Maple **WB** | Solid Weld Rod 1287431
 129 Silk **WB** *



30000 Cabreuva Red **WB** | Solid Weld Rod 1287050
 TA7 Rusty Nail *



81002 French Oak Natural Brown **WB** | Solid Weld Rod 1294315
 130 Sisal *

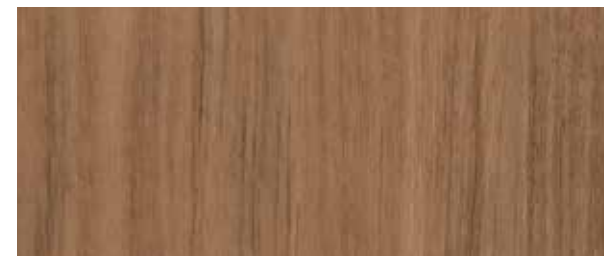

30003 Cabreuva Brown **WB** | Solid Weld Rod 1287032
 TA7 Rusty Nail *



81102 French Oak Natural **WB** | Solid Weld Rod 1287011
 TA7 Rusty Nail *



81029 Light Cherry **WB** | Solid Weld Rod 1287050
 TA7 Rusty Nail *



30027 Brushed Oak Light **CB** | Solid Weld Rod 1287447
 80 Fawn **CB** *

Color Foundations™ is our commitment to always have representation across six key neutral palettes. We've identified Color Foundations neutrals in the following way: **WB** (warm beige), **CB** (cool beige), **WG** (warm grey), **CG** (cool grey), **B** (black), **W** (white).

The Solid Weld Rods listed are coordinating recommendations. Other color weld rods can be used for a variety of visual effects. * Suggested Tarkett colors for finishing borders (wall base). For our complete color offering, reference color guide in back.



FloorScore® certified and meets CA 01350



TVOC ≤ 10 µg/m3

Recycled Content Pre-consumer 30%



A part of ReStart® program



Phthalate free, except for recycled content

roll width = 6'6" nominal (2 m)
roll length = 76' nominal (23 m)

thickness = .080" nominal (2 mm)
adhesives pg. 196

coordinating wall art patterns pg. 188

ACCENT® WOODS (CONT.)



81031 Brazilian Cherry | Solid Weld Rod 1287360
113 Chestnutty *



81100 French Oak White | Solid Weld Rod 1287178
TA3 Castaway CB *



81001 French Oak Medium Grey | Solid Weld Rod 1287373
TA8 Welsh Castle CB *



81000 French Oak Dark Grey | Solid Weld Rod 1287537
29 Moon Rock WG *



30026 Brushed Oak Medium | Solid Weld Rod 1287546
TA4 Gateway WG *

ACCENT® CONCRETE



25003 Grey Beige | Solid Weld Rod 1291839
TA3 Castaway CB *



25002 Chalk | Solid Weld Rod 1291214
27 Mist WG *



25000 Cool Grey | Solid Weld Rod 1287254
TA5 Colonial Grey CG *



25004 Warm Grey | Solid Weld Rod 1287537
80 Fawn CB *



25005 Dark Brown | Solid Weld Rod 1287660
TB1 Peppercorn *

ACCENT® CONCRETE (CONT.)



25001 Dark Grey | Solid Weld Rod 1297647
TA4 Gateway WG *

ACCENT® ZEN



82000 Warm Beige | Solid Weld Rod 1287174
TA1 Tannery WB *



82022 Grey | Solid Weld Rod 1287457
TA5 Colonial Grey CG *



82014 Brown | Solid Weld Rod 1287373
TA8 Welsh Castle CB *



82003 Warm Grey | Solid Weld Rod 1287308
32 Pebble WG *

ACCENT® TISSE



83016 Warm Beige | Solid Weld Rod 1292855
TA1 Tannery CG *



83017 Medium Grege | Solid Weld Rod 1287497
TA8 Welsh Castle CB *



83018 Cool Grey | Solid Weld Rod 1287254
TA5 Colonial Grey CG *



83019 Warm Grey | Solid Weld Rod 1287457
32 Pebble WG *

The Solid Weld Rods listed are coordinating recommendations. Other color weld rods can be used for a variety of visual effects.
* Suggested Tarkett colors for finishing borders (wall base).
For our complete color offering, reference color guide in back.



FloorScore® certified and meets CA 01350

NSF-332 certified gold (UL)



A part of ReStart® program



TVOC ≤ 10 µg/m3



Phthalate free, except for recycled content

Recycled Content Pre-consumer 25%

roll width = 6'6" nominal (2m)

roll length = 75'9" nominal (25 m)

tile sizes =

12"x 12" nominal (305 mm x 305 mm)

24"x 24" nominal (610 mm x 610 mm)

12"x 24" nominal (305 mm x 610 mm)

thickness = .080" nominal (2 mm)

adhesives pg. 196



Performa™

HETEROGENEOUS SHEET FLOORING

No compromise.

Performa™ delivers all the style and strength you need, at a price your project can afford. With contemporary visuals, polyurethane coating and 25 mil wear layer, these stylish designs help you create warm, inviting spaces on time and on budget. Choose between 6 or 12-foot rolls for added speed and flexibility during installation. Each Performa design features the look of natural wood or stone—combining beauty, strength and value in one comprehensive solution.



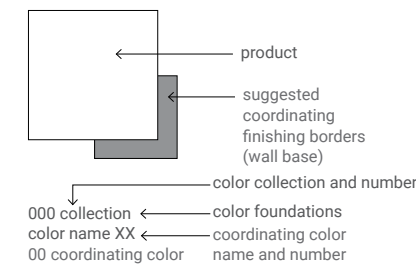

We've identified Color Foundations™ neutrals in the following way:
WB (Warm Beige), CB (Cool Beige), WG (Warm Grey), CG (Cool Grey), B (Black), W (White)

The Solid Weld Rods listed are coordinating recommendations.

* Suggested Tarkett colors for finishing borders (wall base). For our complete color offering, reference color guide in back.

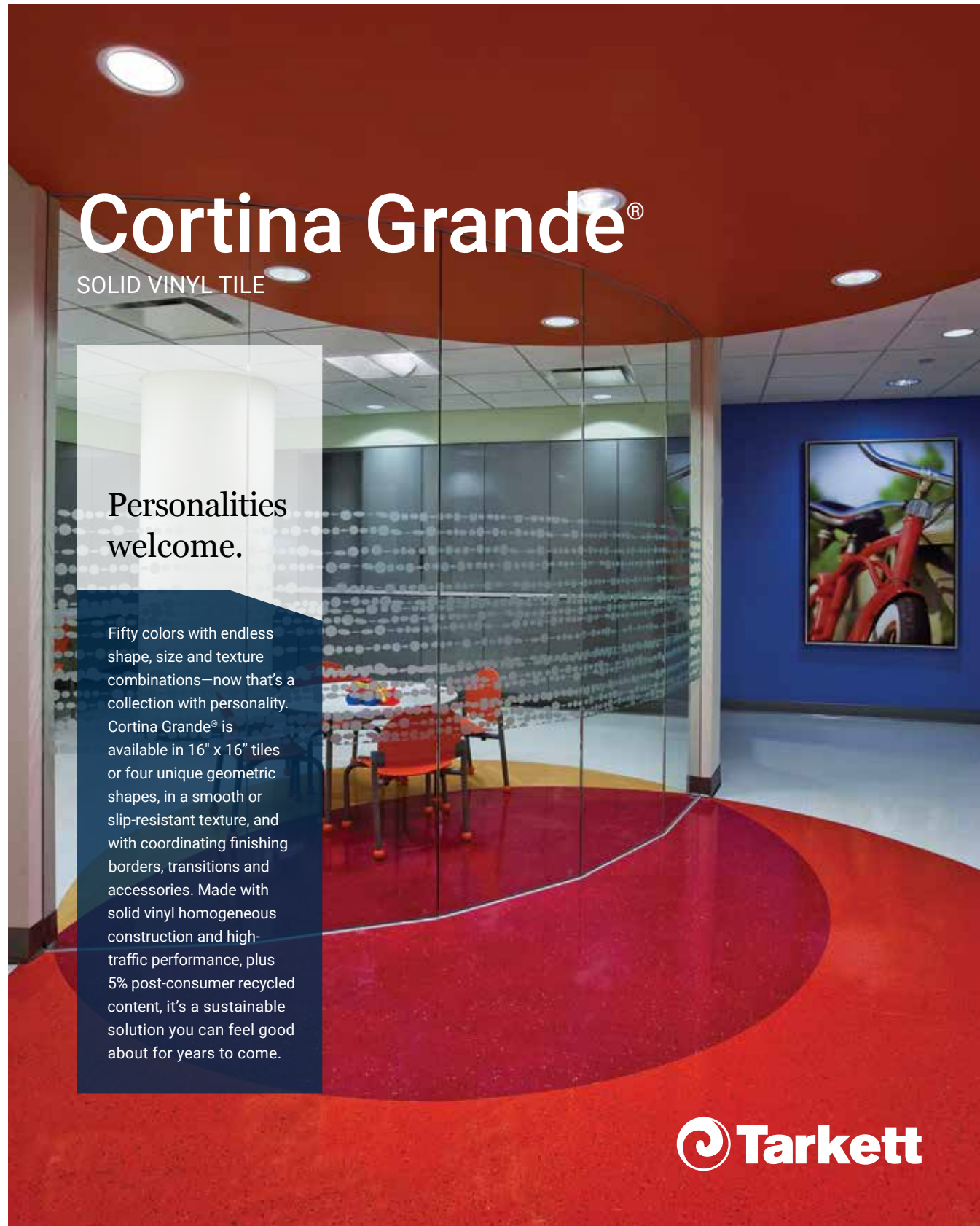











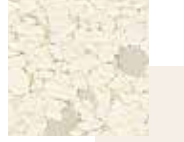

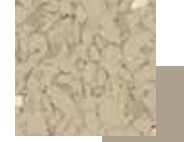
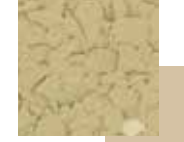

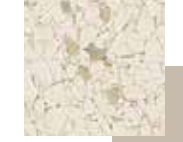

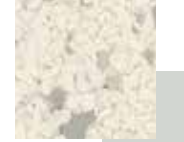
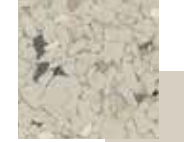



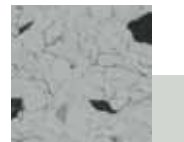



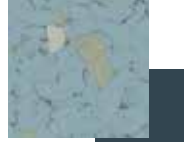



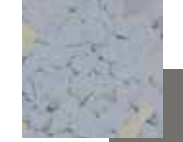



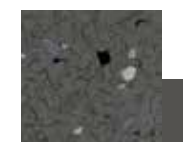
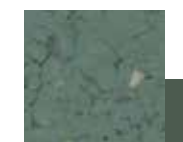

Cortina Grande®

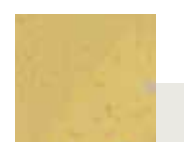
SOLID VINYL TILE

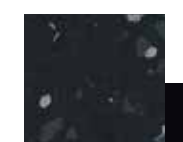
Personalities welcome.

Fifty colors with endless shape, size and texture combinations—now that's a collection with personality. Cortina Grande® is available in 16" x 16" tiles or four unique geometric shapes, in a smooth or slip-resistant texture, and with coordinating finishing borders, transitions and accessories. Made with solid vinyl homogeneous construction and high-traffic performance, plus 5% post-consumer recycled content, it's a sustainable solution you can feel good about for years to come.

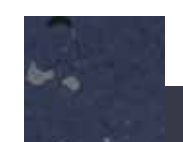

 CG501 Half-n-Half W 68 White Sand W *	 CG503 Ginger Ale WB 09 Clay WB *	 CG410 Camel 280 Shoreline *	 CG506 Sponge Beige WB 129 Silk WB *	 CG412 Heather WG 27 Mist WG *	 CG502 Picnic Basket CB 31 Zephyr CB *
 CG504 Smooth Sand WB 11 Canvas WB *	 CG512 Warm Day CB 80 Fawn CB *	 CG405 Cinder White CG 23 Vapor Grey CG *	 CG404 Pumice WG 24 Grey Haze WG *	 CG509 Campy WG 29 Moon Rock WG *	 CG510 Grille Grey WG 32 Pebble WG *
 CG402 Black & White W 08 Icicle W *	 CG508 Cooler CG 23 Vapor Grey CG *	 CG511 Cool Crete CG 38 Pewter CG *	 CG409 Ginger WB 45 Sandewood WB *	 CG527 Golden 130 Sisal *	 CG513 Splash CG 38 Pewter CG *
 CG518 Tide Bubbles 92 Blue Lagoon *	 CG505 On The Green 151 Iguana *	 CG526 Penny TA7 Rusty Nail *	 CG507 Sweet Pea TH1 Glenhaven *	 CG514 Violet Fields WG TG6 Mink WG *	 CG521 Beckon Blue 58 Windsor Blue *
 CG517 Hedgely 190 Greege *	 CG516 SeaSun 282 Vaporize *	 CG515 Phlox 41 Sea Breeze *	 CG524 Crocus 23 Vapor Grey CG *	 CG403 Loam WG 20 Charcoal WG *	 CG519 Peabody 73 Palm Leaf *
 CG523 Bluebells 84 Blue Jeans *	 CG520 Blossom TB2 Boxwood *	 CG531 Sunny Day TG1 Snowbound *	 CG529 Speedy 163 Salsa CG *	 CG534 Blanket Brown 284 Ganache *	 CG401 Onyx B 40 Black B *
 CG528 Pom Poms 113 Chestnutty *	 CG530 Snappy 62 Tangerine Tango *	 CG532 Racer 106 Skinny Dip *	 CG533 Queen Anne B 44 Dark Brown B *	 CG522 Spring Leaf 190 Greege *	 CG525 Aster 14 Topical Storm *









**Karim Kolors and Shapes.
Go boldly.**

Designed exclusively by Karim Rashid, Karim Kolors and Shapes boldly transform a space and infuse it with creative energy. Karim Kolors are available in 16" x 16" square tiles, as well as four unique geometric shapes to push the design envelope even further.

Karim Shapes are available for all Cortina Grande® Solid Vinyl Tile SKUs.

			
CG489 Khite W 08 Icicle W *	CG482 Koise 192 Tidewater *	CG486 Kink 08 Icicle W *	CG488 Korange 62 Tangerine Tango *
			
CG485 Kurp 162 Sovereign *	CG487 Krose 01 Snow White W *	CG484 Klue 106 Skinny Dip *	CG483 Klime 50 White W *

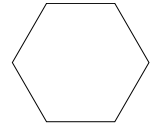
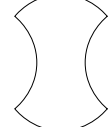
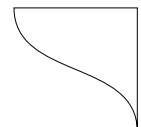
FOUR UNIQUE SHAPES IN ADDITION TO 16" x 16" SQUARES

			
HIVE	NODE	TIDE	TRI
			

*Suggested Tarkett colors for finishing borders (wall base). For our complete color offering, reference color guide in back.

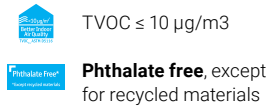
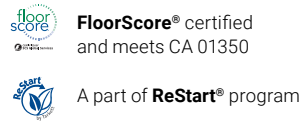

Recycled Content
Pre-consumer 23%
Post-consumer 6%

adhesives pg. 196

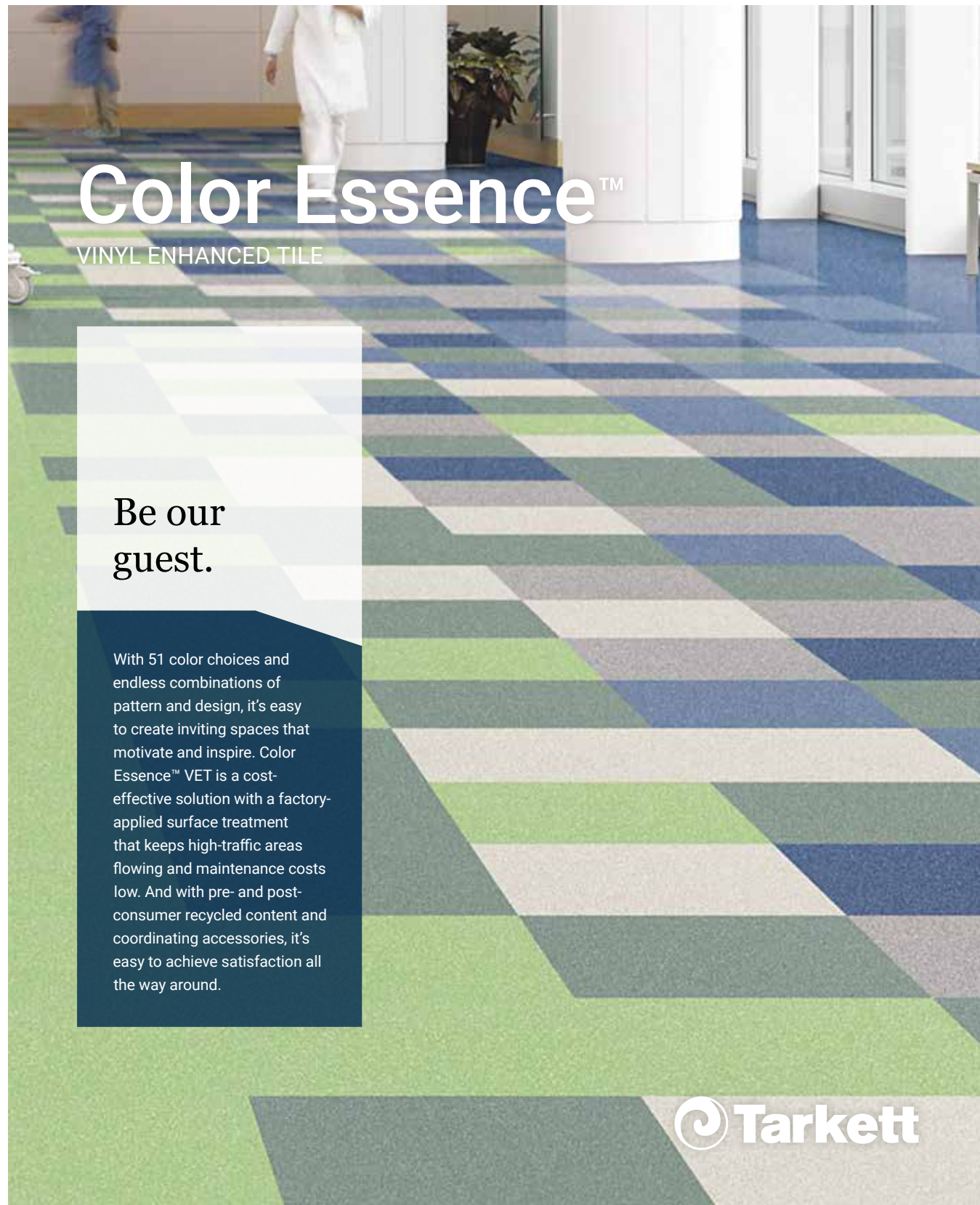

Color Essence™

VINYL ENHANCED TILE

Be our guest.

With 51 color choices and endless combinations of pattern and design, it's easy to create inviting spaces that motivate and inspire. Color Essence™ VET is a cost-effective solution with a factory-applied surface treatment that keeps high-traffic areas flowing and maintenance costs low. And with pre- and post-consumer recycled content and coordinating accessories, it's easy to achieve satisfaction all the way around.



tile size = 12" x 12" (305 mm x 305 mm)

thickness = 1/8" (3.2 mm)

Slip-resistant options available.

CE101 Linen WG 27 Mist WG *	CE102 Ice Cave W 50 White W *	CE103 White Chocolate W 68 White Sand W *	CE104 Warm & Fuzzy CB 31 Zephyr CB *	CE105 Hub Cap CG 23 Vapor Grey CG *	CE106 Cool Idea CG 21 Platinum CG *
CE107 Champagne WB 11 Canvas WB *	CE108 Hopscotch WB 129 Silk WB *	CE109 Lakefront CG 262 Drizzle CG *	CE110 Misty Mountain 282 Vaporize *	CE111 Mysterious 282 Vaporize *	CE112 Ale WB 09 Clay WB *
CE113 T-Leaf 151 Iguana *	CE114 Haze 199 Dockside *	CE115 Ginger WB 49 Beige WB *	CE116 Peanut Butter 33 Adobe Peach *	CE117 Just Offshore TB3 Dover CG *	CE118 Fender CG 38 Pewter CG *
CE119 Julep TH1 Glenhaven *	CE120 Snuggle Up CB 80 Fawn CB *	CE121 Tranquility 23 Vapor Grey CG	CE122 Blue Bayou 58 Windsor Blue *	CE123 Lighthouse 72 Harbour *	CE124 Meadow 59 Heather Green *
CE125 What a Moss 151 Iguana *	CE126 Coast 58 Windsor Blue *	CE127 Pretty Putty CB 121 Cement CB *	CE128 Axel WG 29 Moon Rock WG *	CE129 Wild Blue Yonder 84 Blue Jeans *	CE130 Blue 4 U 84 Blue Jeans *
CE131 Thunderstruck WG 199 Dockside WG *	CE132 Maple Syrup 132 Espresso *	CE133 Amaized 130 Sisal *	CE134 Grape 162 Sovereign *	CE135 Uniformity 106 Skinny Dip *	CE136 Fizz TG8 Spicy Chip *

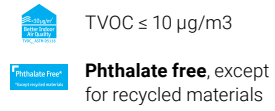
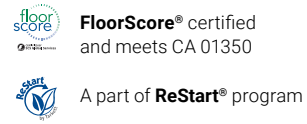

Recycled Content
Pre-consumer 23%
Post-consumer 6%

tile size = 12" x 12" (305 mm x 305 mm)

adhesives pg. 196

thickness = 1/8" (3.2 mm)

Slip-resistant options available.

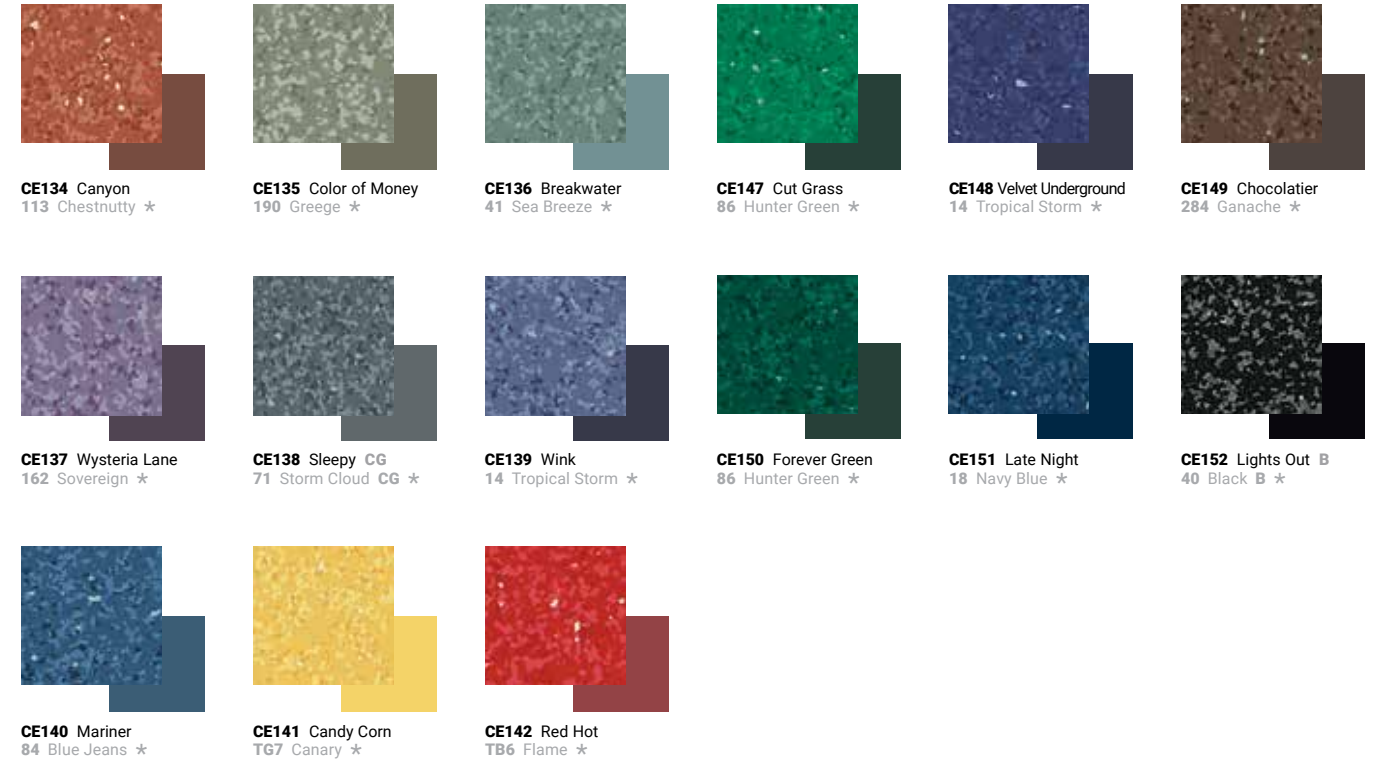

* Suggested Tarkett colors for finishing borders (wall base). For our complete color offering, reference color guide in back.



Azterra™























VINYL ENHANCED TILE

Make your masterpiece.

Azterra™ VET achieves the look of marble infused with granite-like particles to create a chic, terrazzo-inspired floor tile. Its UV-cured, factory-applied polyurethane surface treatment stands up to heavy traffic and requires less maintenance from the start. Available in 23 colors, Azterra is ideal for areas that receive less routine maintenance, keeping ROI up and life-cycle costs down.



tile size = 12" x 12" (305 mm x 305 mm)
thickness = 1/8" (3.2 mm)
adhesives pg. 196

 AT102 Buffed Concrete CG 24 Grey Haze WG *	 AT101 Marbled WB 11 Canvas WB *	 AT103 Warm Sand WB 31 Zephyr CB *	 AT105 Perla CB 27 Mist WG *
 AT104 Gray Rock WG 29 Moon Rock WG *	 AT109 Oxide CB 121 Cement CB *	 AT118 Rose Quartz CB 22 Pearl CB *	 AT119 Amber WB TA1 Tannery WB *
 AT123 Adelite CB TB3 Dover CG *	 AT108 Copper WB 09 Clay WB *	 AT110 Assuro CG 71 Storm Cloud CG *	 AT107 Mineral CG 38 Pewter CG *
 AT121 Humite TB1 Peppercorn *	 AT122 Barite CG 27 Mist WG *	 AT124 Cobaltite CG 38 Pewter CG *	 AT112 Ferrous 76 Cinnamon *
 AT125 Amethyst CB TA5 Colonial Grey CG *	 AT126 Pyrite WG 27 Mist WG *	 AT111 Cassel B 40 Black B *	 AT120 Moonstone CB TA8 Welsh Castle CB *
 AT106 Iron Ore WG 20 Charcoal WG *	 AT113 Brown Earth 284 Ganache *	 AT114 Black Earth B 40 Black B *	

* Suggested Tarkett colors for finishing borders (wall base). For our complete color offering, reference color guide in back.



FloorScore® certified and meets CA 01350



A part of **ReStart**® program



TVOC ≤ 10 µg/m3



Phthalate free, except for recycled materials

Recycled Content
Pre-consumer 15%
Post-consumer 1.9%

tile size = 12" x 12" (305 mm x 305 mm)
thickness = 1/8" (3.2 mm)

adhesives pg. 196



Tarkett VCT

VINYL COMPOSITION TILE

Classic essentials.

Tarkett VCT brings great design and outstanding value together in a long-trusted solution for education and retail environments. This efficient color palette offers 29 of our most popular colorways, including contemporary neutrals and pops of color for branding accents. Constructed with 85% limestone, this hard-working staple is phthalate-free, FloorScore® certified, and 100% post-consumer recyclable right back into VCT.



1913 SandDollar TG1 Snowbound W *	1314 Beige 50 White W *	1367 Sierra Beige 49 Beige WB *	1789 Sugar Cane 08 Icicle W *	1824 Sand Castle 31 Zephyr CB *	1345 Beige Taupe 195 Ash WG *
1862 Cane 50 White W *	1365 Dark Taupe TG6 Mink WG *	1314 White Grey 50 White W *	1324 Cool Gray TG2 Shark Fin CG *	1318 White Black TB3 Dover CG *	650441531 Cooler Gray TB3 Dover CG *
1364 Dark Gray TG3 Iron Mountain CG *	1310 White Blue 50 White W *	1374 Charcoal TG4 Black Magic B *	1328 Black White 40 Black B *	1336 Yellow TG1 Snowbound W *	1608 Orange Crush 62 Tangerine Tango *
1379 Red 15 Cabernet *	1278 Merlot 85 Burgundy *	1786 Cloudy Day 262 Drizzle CG *	1350 Blue Lagoon 84 Blue Jeans *	1370 Hudson Blue 18 Navy Blue *	1238 Ocean Tide 92 Blue Lagoon
1320 Refined White Multi 50 White W *	1240 Limeaid 73 Palm Leaf *	1298 Clover 59 Heather Green *	VS300 Black 50 White W *	VS304 White TG4 Black Magic B *	



Multi-Functional/Sports Flooring

Meet our MVP lineup. With heroic strength and all-star comfort, these flooring surfaces are built for long-distance performance.

130
Triumph and Inertia®

138
Training®

136
Replay®

140
Slidelock®







FloorScore® certified
and meets CA 01350



A part of ReStart® program



Phthalate free, except
for recycled materials



Cradle to Cradle
Bronze certified

textures pg. 29

adhesives pg. 196



Triumph and Inertia®

MULTI-FUNCTIONAL AND SPORTS FLOORING

It's all about teamwork.

For optimal coordination, Triumph and Inertia® are available in identical colorways. Choose from 20 Standard Speckled and 6 Mesto® colorways, all in our Hammered texture. Solid colors available by special request.



TRIUMPH / INERTIA® - STANDARD SPECKLED



LB4 Mottled Egg WG
24 Grey Haze WG *



LD7 Lunar Explorer WG
29 Moon Rock WG *



LB2 Great Plains WB
49 Beige WB *



SPECKLED
KJ8 Strong Blue



COORDINATING WALLBASE
70 Bluest

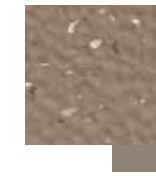

LE4 Log Cabin CB
80 Fawn CB *



LC7 Best Seller CG
23 Vapor Grey CG *



KJ6 Grey Area CG
38 Pewter CG *



MESTO
KN3 Bluer



LB9 Rainstorm WG
20 Charcoal WG *



KK3 Tea Leaves
59 Heather Green *



KJ9 Forestation
86 Hunter Green *

It's all about teamwork. For optimal coordination, Triumph and Inertia® are available in identical colorways. Choose from 20 Standard Speckled and 6 Mesto® colorways, all in our Hammered texture. Solid colors are also available by special request.



KL3 Bright Sun
TG1 Snowbound W *



KL2 Passion
TB6 Flame *



KJ7 Burged
85 Burgundy *



KK6 Fortunate WB
130 Sisal *



KJ4 Cocolite
149 Milk Chocolate *



KJ3 Brownout
47 Brown *



KJ2 Tidal
58 Windsor Blue *



KJ8 Strong Blue
70 Bluest *



KJ1 Marino
18 Navy Blue *



KJ5 Browns Town
63 Burnt Umber B *



LB8 Vortex B
40 Black B *

TRIUMPH / INERTIA® - STANDARD MESTO



KN6 Plainer WB
49 Beige WB *



KN5 Lucky WB
45 Sandelwood WB *



KN2 Expedition WG
29 Moon Rock WG *



KN1 Rainy Day WG
20 Charcoal WG *



KN3 Bluer
70 Bluest *



KN4 Tree Top
86 Hunter Green *

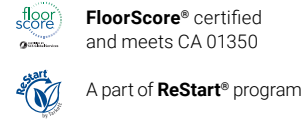

FloorScore® certified and meets CA 01350



Cradle to Cradle Bronze certified

textures pg. 29
adhesives pg. 196

Recycled Content Pre-consumer 53%

Phthalate free, except for recycled materials

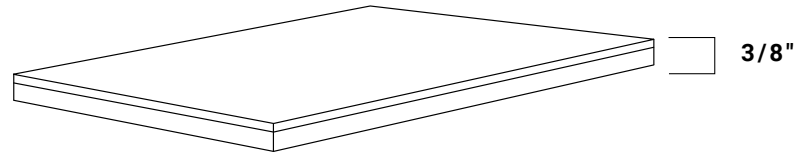

3/8"

TRIUMPH

Never hurts to start off a few steps ahead. And that's what you get with Triumph flooring. Tough, flexible and performance-ready, this floor is engineered to hold up under constant traffic, sports activities and heavy sporting equipment. Made of 3/8" rubber, Triumph absorbs noise and resists impact, shock, spikes and skates. It's ideal for any high-energy application. And with a wide range of solid and patterned colors, everybody wins.

APPLICATIONS

- fitness centers
- workout rooms
- ski lodges
- ice rinks¹
- weight rooms
- golf course indoor facilities¹
- dressing rooms²
- locker rooms²
- pro shops²
- indoor stadium tunnels²
- physical therapy rooms³
- retail, office and public areas
- correctional facilities⁴
- daycare centers
- assembly and production areas⁵

TRIUMPH WITH HAMMERED TEXTURE	Thickness	Speckled	Mesto®	Prima® Marbleized™ and Olio®	Solid Colors
Square Edge Tile 24" x 24"	3/8"	20 colorways available	6 colorways available	SO	SO
Interlocking Tile 24" x 24" (23" x 23" net)	3/8"	20 colorways available	6 colorways available	SO	SO
SlideLock® Tile 24" x 24" net (studded back)	3/8"	20 colorways available	6 colorways available	SO	SO

Matching accessories available in solid colors (not skate and spike resistant).

For more detailed information regarding product features, installation, maintenance, specifications and case study installations, visit tarkettna.com.

Interlocking tiles may be used where lightweight rolling loads are present.

Rolling traffic is not permitted over SlideLock tile.

SO = Special Order

¹ Specify Square Edge or Interlocking only

² Specify Square Edge or Interlocking for ice skate blade and spike traffic

³ Specify Square Edge or Interlocking for wet areas

⁴ Specify Square Edge only

⁵ Triumph is not oil and grease resistant

Note: SlideLock requires different maintenance than Square Edge and Interlocking profiles.

Rapidly Renewable Resources

All profiles 7%

ASTM D 2047 slip resistance

ASTM D 2240 hardness: 70 SHORE A

ASTM D 3389 abrasion: <1.0 gram/1,000 cycles

ASTM DIN 18035 basketball recovery test value at 99%

ASTM E 648/NFPA 253 Class 1

ASTM E 662/NFPA 258, 450 or less smoke rating

ASTM F 970 static load limit: 0.0% residual indentation at 250-lb load

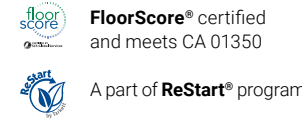

FloorScore® certified and meets CA 01350



Cradle to Cradle Bronze certified

Recycled Content 1/4" profiles pre-consumer 53% 1/4" profiles pre-consumer 53%

textures pg. 29
adhesives pg. 196

Phthalate free, except for recycled materials

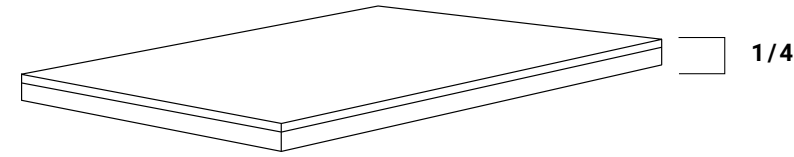

1/4"

INERTIA®

Let's end the rival between price and performance. This 1/4" rubber floor provides a more affordable alternative to Triumph, for applications that don't involve such extreme activity. Identical to Triumph aesthetically, Inertia also blends with it seamlessly. This allows you to achieve various levels of functionality within high-performance areas. Now that's an accomplishment you simply can't beat.

APPLICATIONS

- fitness centers
- workout rooms
- ski lodges
- dressing rooms¹
- locker rooms¹
- pro shops¹
- indoor stadium tunnels¹
- physical therapy rooms²
- retail, office and public areas
- correctional facilities
- daycare centers
- assembly and production areas³

INERTIA WITH HAMMERED TEXTURE	Thickness	Speckled	Mesto®	Prima® Marbleized™ and Olio®	Solid Colors
Square Edge Tile 24" x 24" (smooth back)	1/4"	20 colorways available	6 colorways available	SO	SO
SlideLock® Tile 24" x 24" net (studded back)	1/4"	20 colorways available	6 colorways available	SO	SO
SlideLock Tile 24" x 24" net (studded back)	3/8"	SO	SO	SO	SO

Matching accessories available in solid colors (not skate and spike resistant).

For more detailed information regarding product features, installation, maintenance, specifications and case study installations, visit tarkettna.com.

Interlocking tiles may be used where lightweight rolling loads are present.

Rolling traffic is not permitted over SlideLock tile.

SO = Special Order

¹ Specify Triumph Square Edge and Interlocking for ice skate blade and spike traffic

² Specify Square Edge and Interlocking for wet areas

³ Inertia is not oil and grease resistant

Note: SlideLock requires different maintenance than Square Edge and Interlocking profiles

Rapidly Renewable Resources

1/4" profiles 5%

3/8" profiles 7%

ASTM D 2047 slip resistance

ASTM D 2240 hardness: ≥ 85 SHORE A

ASTM D 3389 abrasion:

<1.0 gram/1,000 cycles

ASTM E 648/NFPA 253 Class 1

ASTM E 662/NFPA 258, 450 or less smoke rating





Replay®

MULTI-FUNCTIONAL AND SPORTS FLOORING

Game on.

Replay® knows all about performance enhancement. Made from recycled rubber tires, this floor is remarkably resistant to the impact of golf spikes, ice skate blades, cleats, barbells and heavy rolling equipment. It also absorbs shock to athletes' backs and joints, as well as noise from foot traffic. Easy to install, maintain and afford, Replay comes in 12 colorways—in tiles or by the roll—making it the perfect, sustainable choice for a range of high-energy environments.

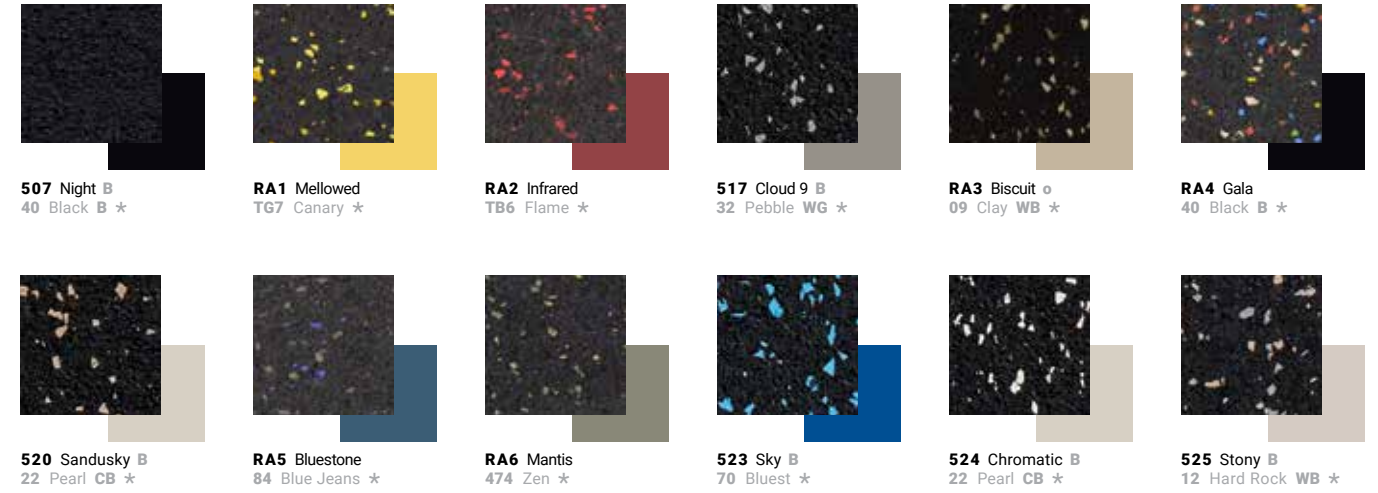

* Suggested Tarkett colors for finishing borders (wall base).
For our complete color offering, reference color guide in back.

APPLICATIONS

- ice rinks
- weight rooms
- fitness centers
- workout rooms
- golf course facilities
- ski lodges
- dressing and locker rooms
- pro shops
- indoor stadium tunnels
- physical therapy rooms
- retail, office and other public areas
- correctional facilities¹
- assembly and production areas²



INTERLOCKING TRANSITION FOR REPLAY

Replay is available in Interlocking tiles for loose-lay applications, square tiles for permanent placement or sheet for more seamless installations. Complete installation of Interlocking tile edges with our transition that creates a safe passage to the new floor.

REPLAY®	1/4" Thickness	3/8" Thickness	1/2" Thickness
 Square Edge Tile 24" x 24"	SO	STD	N/A
 Interlocking Tile 25" x 25" (24" x 24" net)	SO	STD	SO
 Roll 48" wide	STD 75'	STD 50'	SO 50'

Please note: Specify 3/8" or 1/2" Replay for skate blades, shoe spikes and free weight areas.

Standard Replay is made from 92% post-consumer recycled tires. Recognizable visual differences can occur from roll to roll or tile to tile. This does not detract from the performance of the product and is considered part of the manufacturing process.

For best appearance, follow Tarkett's installation and maintenance instructions.

For more detailed information regarding product features, installation, maintenance, specifications and case study installations, visit tarkettna.com.

¹- Specify Square Edge or Roll only

²- Replay is not oil and grease resistant

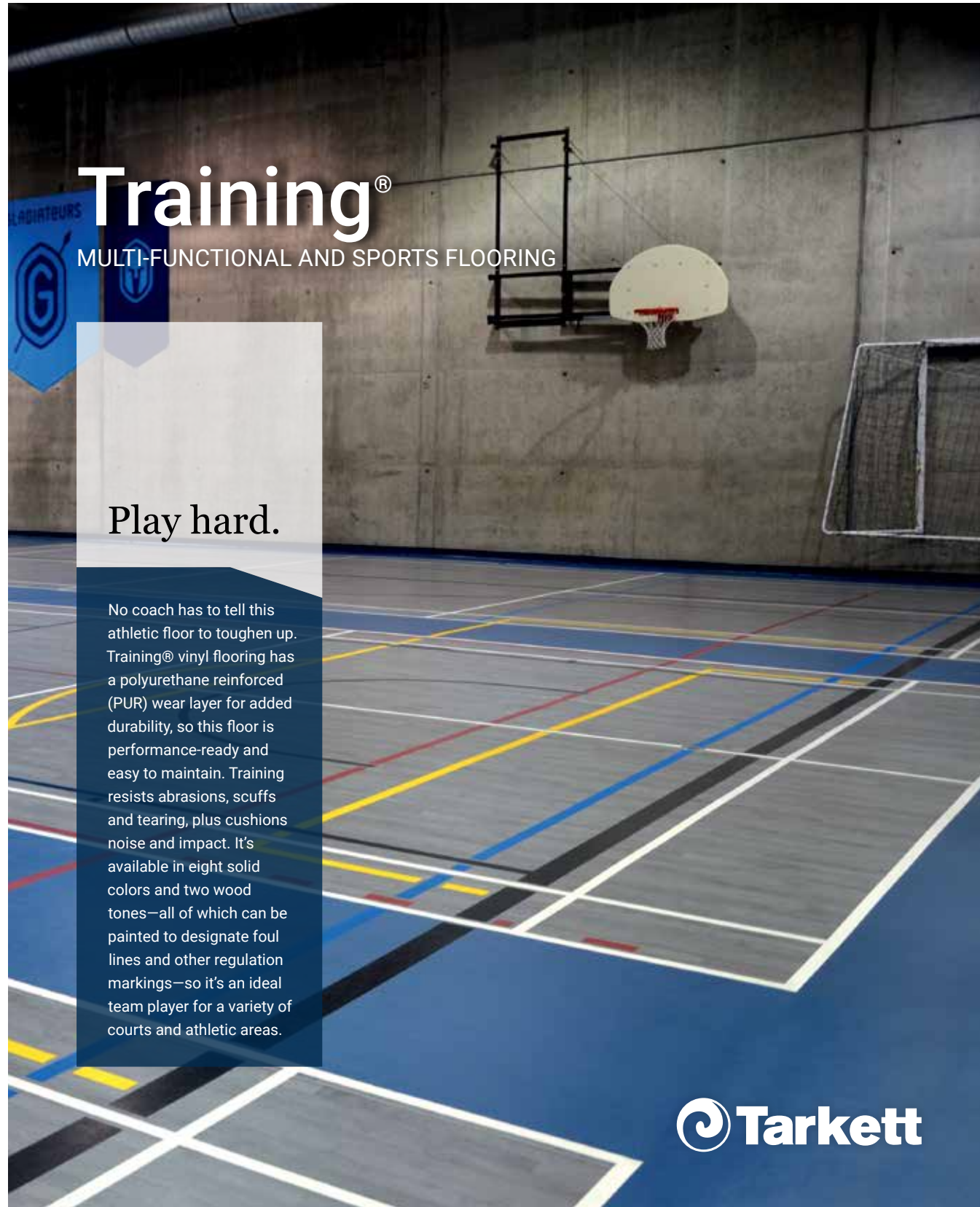

Training®

MULTI-FUNCTIONAL AND SPORTS FLOORING

Play hard.

No coach has to tell this athletic floor to toughen up. Training® vinyl flooring has a polyurethane reinforced (PUR) wear layer for added durability, so this floor is performance-ready and easy to maintain. Training resists abrasions, scuffs and tearing, plus cushions noise and impact. It's available in eight solid colors and two wood tones—all of which can be painted to designate foul lines and other regulation markings—so it's an ideal team player for a variety of courts and athletic areas.



roll width = 6'6" nominal (2 m)
roll length = 67' nominal (20 m)
thickness = .197" nominal (5 mm)



8009 Grey CG
Weld Rod 1287183
28 Medium Grey CG *



8016 Royal Blue
Weld Rod 1291367
70 Bluest *



8017 Sky Blue
Weld Rod 1287172
70 Bluest *



8015 Teal
Weld Rod 1287317
147 South Seas *



8002 Field Green
Weld Rod 1291365
TG1 Snowbound W *



8014 Forest Green
Weld Rod 1287316
59 Heather Green *



8012 Orange
Weld Rod 1287139
62 Tangerine Tango *



8011 Red
Weld Rod 1291808
TB6 Flame *

Cover your bases.

Ideal for sports floor installations, Vent Cove Base provides a heavy duty, corner-moulded design that will perform for years with minimal maintenance. The vented design permits air circulation for suspended floors and has a 3" wide toe to cover expansion voids.



9002 Golden Maple WB
Weld Rod 1291368
130 Sisal *



9001 Beech WB
Weld Rod 1291363
129 Silk WB *

APPLICATIONS

- gymnasiums
- health clubs
- basketball courts
- volleyball courts
- badminton courts
- aerobic areas
- racquetball courts
- exercise rooms
- gymnastics rooms
- table tennis rooms
- cafeterias

The Solid Weld Rods listed are coordinating recommendations. Other color weld rods can be used for a variety of visual effects.



FloorScore® certified and meets CA 01350



Cradle to Cradle Bronze certified



Phthalate free, except for recycled materials



A part of ReStart® program

Recycled Content Pre-consumer 34%



Slidelock®

MULTI-FUNCTIONAL AND SPORTS FLOORING

Float above it.

SlideLock rubber tile is a glueless floating system, and works beautifully as a permanent installation or temporary flooring solution. With a patented hidden locking system and no need for adhesive, SlideLock improves the speed and flexibility of project installations, while maintaining access to mechanicals below the subfloor. The tiles are locked together using a seam roller, and individual tiles can easily be removed and replaced, without use of special tools. For a variety of applications where comfort underfoot, slip-resistance and sound absorption are must-haves, SlideLock is a perfect solution.



Tile Sizes =
12"x12" (305mm x 305mm)
12"x24" (305 x 610 mm),
24"x24" (610 x 610 mm)

adhesives pg. 196
thickness = .1/4" (2.3 mm)

Cover your bases.

New marbleized colorways in the SlideLock Configurations line emulate the look and feel of stones and woods. Colorways blend in to any environment, while helping to hide subfloor irregularities with the thick ¼" gauge. SlideLock is available in three different sizes to provide unmatched design flexibility. Choose from 12" x 12", 12" x 24" or 24" x 24" tiles to fill the space, or create a unique design using a combination of

all three. Tiles can be installed in a traditional corner-to-corner pattern, or offset to create interesting visuals.

The swatches shown are created from a combination of four each 12" x 24" tiles to illustrate the random marbleization.



SJ3 Macro W
27 Mist WG *



SH7 Access WG
24 Grey Haze WG *



SJ4 Megabyte CB
27 Mist WG *



SH8 Bandwidth W
TB3 Dover Grey WG *



SH9 Data CG
23 Vapor Grey CG *



SJ5 Memory WB
09 Clay WB *



SJ7 Syntax CB
283 Toast *



SJ6 Software CB
45 Sandalwood WB *



SJ1 Gigabyte CG
TA5 Colonial Grey CG *



SJ2 Kilobyte WG
TA4 Gateway WG *

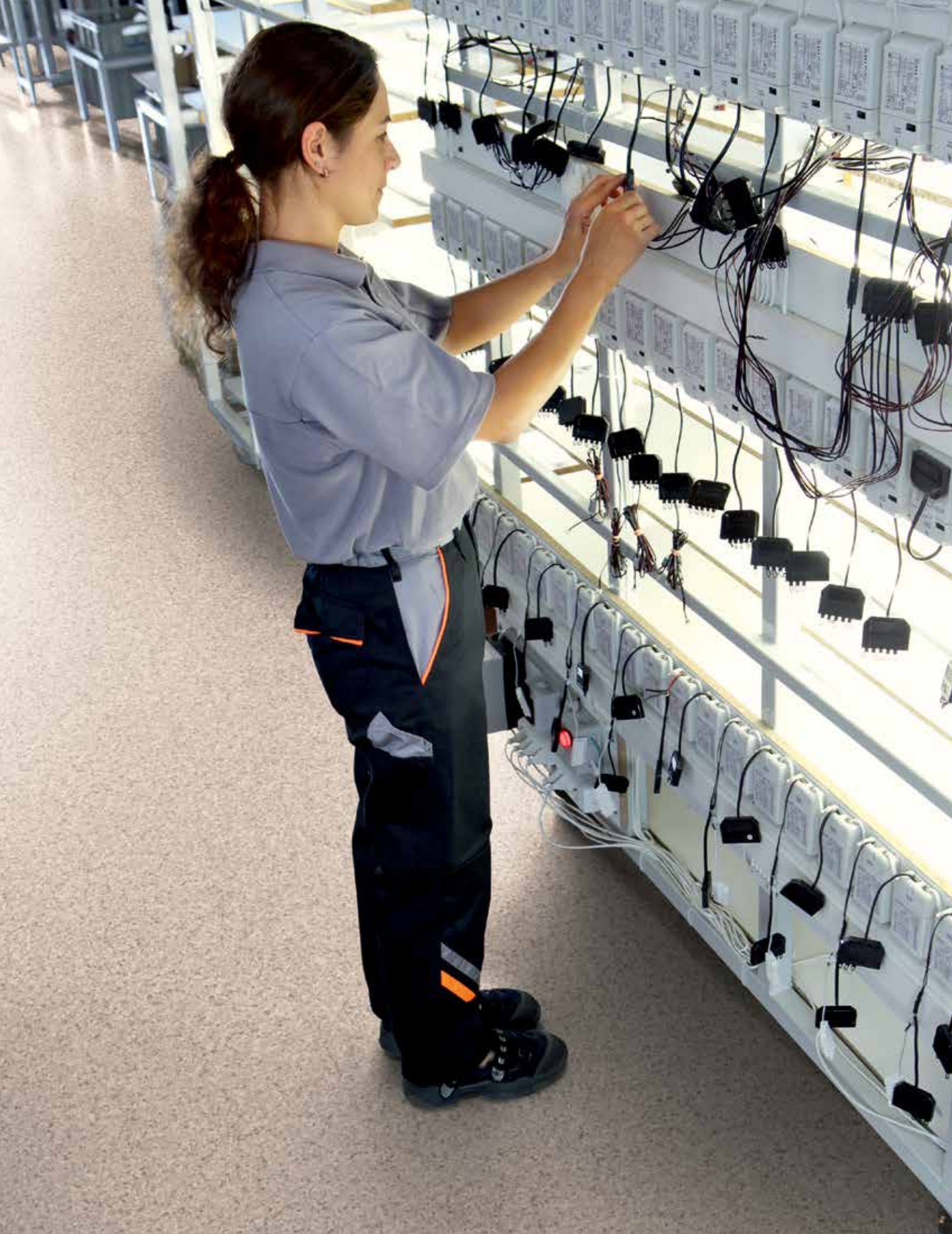

Specialty Applications

When the space you're designing serves an especially unique purpose, the flooring you choose has to keep up. From recording studio acoustics to static control in the lab, these specialty floors are ready to perform.

144

iQ™ Optima®
Acoustiflor®

149

iQ™ Granit™ SD

154

Safe-T-First®

146

Acczent® Wood
Acoustiflor®

150

Granit™ Safe-T

147

Veneto Acoustiflor®

152

Defiant™ Oil and Grease
Resistant Rubber Tile
and Stair Treads

148

iQ™ Toro SC

153

Terra-Turf®
Recycled Tile

Clean Path
Entrance Barrier
Modular Tile





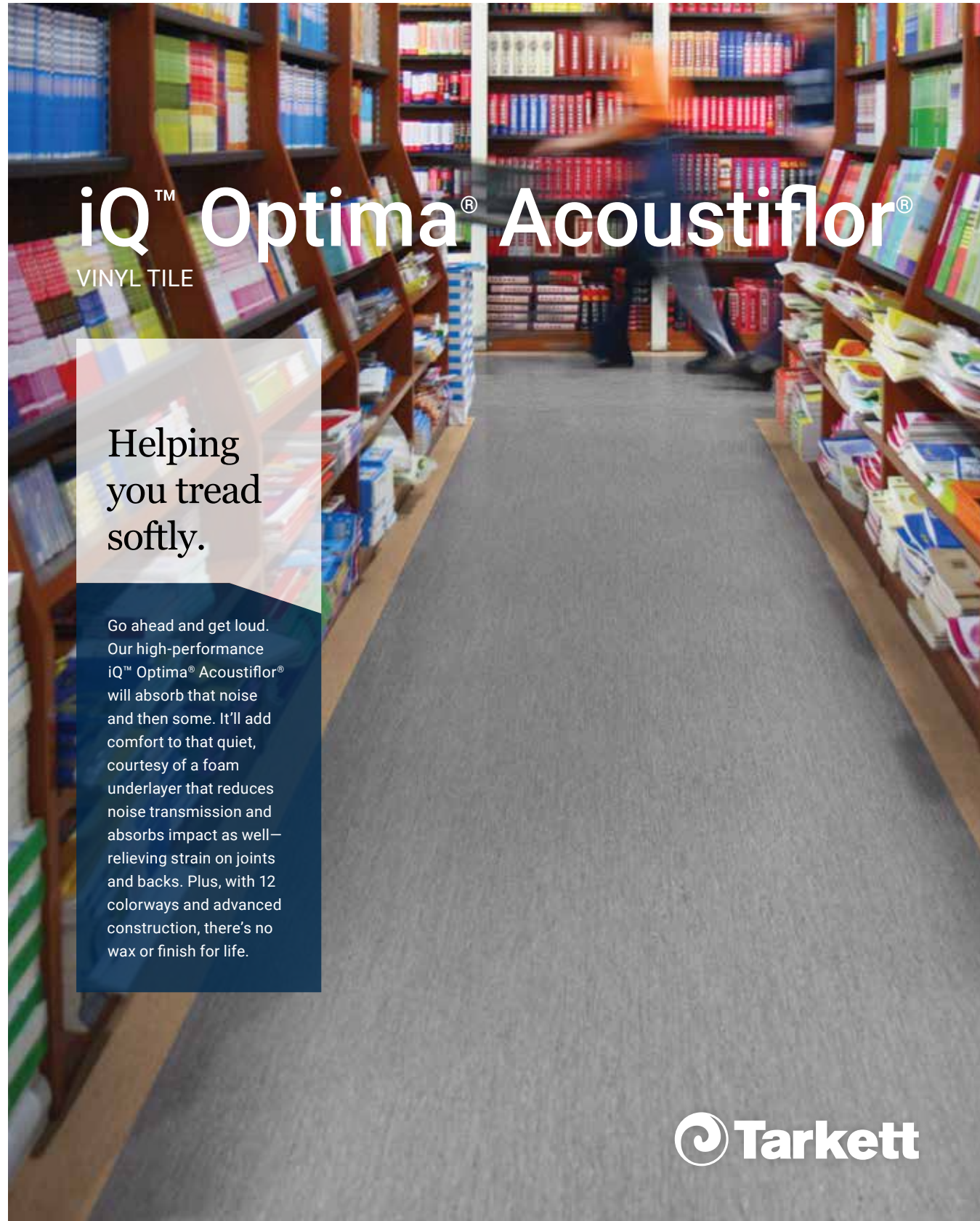
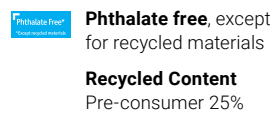
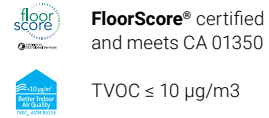

iQ™ Optima® Acoustiflor®

VINYL TILE

Helping you tread softly.

Go ahead and get loud. Our high-performance iQ™ Optima® Acoustiflor® will absorb that noise and then some. It'll add comfort to that quiet, courtesy of a foam underlayer that reduces noise transmission and absorbs impact as well—relieving strain on joints and backs. Plus, with 12 colorways and advanced construction, there's no wax or finish for life.



roll width = 6'5" nominal (1.95 m)

roll length = 82'7" nominal (25 m)

thickness = .146" nominal (3.7 mm)

adhesives pg. 196

862 Raw Ivory W Solid Weld Rod 1291862 Multicolor 1290025 22 Pearl CB *	821 Frothy Latte CB Solid Weld Rod 1291821 Multicolor 1290159 31 Zephyr CB *	860 Malt WB Solid Weld Rod 1287039 Multicolor 1290066 280 Shoreline *	825 Caramel Infusion WB Solid Weld Rod 1291203 Multicolor 1290024 11 Canvas WB *	824 Yellow Mustard Solid Weld Rod 1287827 Multicolor 1290334 TG7 Canary *	856 Morning Sky Solid Weld Rod 1288905 Multicolor 1290051 84 Blue Jeans *
857 Popiu Bay Solid Weld Rod 1287841 Multicolor 1290336 70 Bluest *	853 Thunderhead CG Solid Weld Rod 1292388 Multicolor 1290022 38 Pewter CG *	866 Sidewalk CG Solid Weld Rod 1287842 Multicolor 1290026 38 Pewter CG *	845 Stroke of Midnight B Solid Weld Rod 1291845 Multicolor 1290034 40 Black B *	257 Tiger Glow Solid Weld Rod 1287834 Multicolor 1290352 273 Copper Penny *	246 Egyptian Scrolls Solid Weld Rod 1292319 Multicolor 1290290 280 Shoreline CB *
861 Clover Leaf Solid Weld Rod 1287592 Multicolor 1290337 475 Marshland *	820 Coffee Shoppe WB Solid Weld Rod 1287005 Multicolor 1290099 49 Beige WB *	899 Flannel Blanket CB Solid Weld Rod 1287447 Multicolor 1290088 80 Fawn *			
873 Koala Bear CG Solid Weld Rod 1287524 Multicolor 1290122 469 Mystify CG *	864 Concrete Slab CG Solid Weld Rod 1287412 Multicolor 1290028 21 Platinum CG *	871 Arctic Winter W Solid Weld Rod 1287522 Multicolor 1290120 50 White W *			
247 Almond Cream WB Solid Weld Rod 1291615 Multicolor 1290342 49 Beige WB *	874 Hardwired WG Solid Weld Rod 1287840 Multicolor 1290338 20 Charcoal WG *				

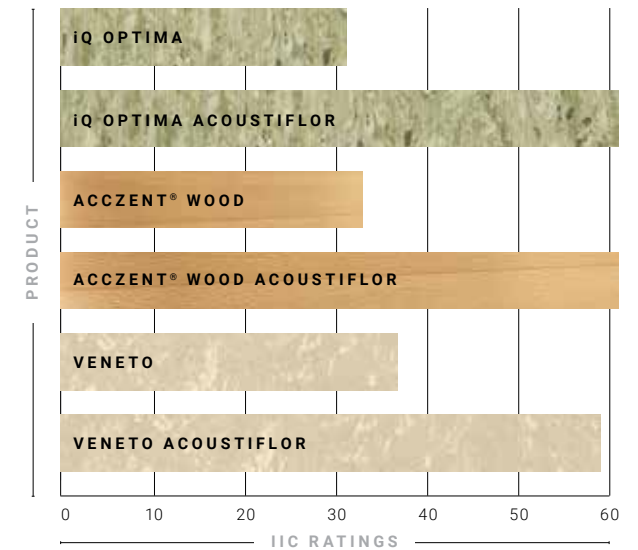

ACOUSTIFLOR VS. STANDARD PRODUCT

Floor coverings with an IIC rating above 45 dB are used to help reduce impact sound transmissions to lower levels, thus reducing or eliminating noises. Visit tarkettna.com for our latest IIC ratings.

The Solid and Multicolor Weld Rods listed are coordinating recommendations. Other color weld rods can be used for a variety of visual effects.

* Suggested Tarkett colors for finishing borders (wall base). For our complete color offering, reference color guide in back.

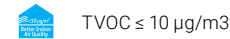
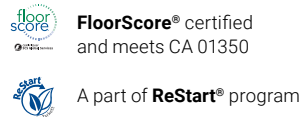

Recycled Content
Pre-consumer 30%

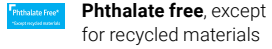

A Acoustic | Sound Absorption

roll width = 6'6"
nominal (2 m)

roll length = 75'9"
nominal (23 m)

thickness = .136"
nominal (3.45 mm)

adhesives pg. 196

Acczent® Wood Acoustiflor®. Get tranquil.

Get the warmth and beauty of a wood floor without the hollow echo. With this sound- and impact-absorbing vinyl sheet, you'll find that quiet and comfort come in four lovely colorways. Add the substantial 28 mil wear layer, and you'll also get resistance to indentation, abrasion and tearing. Which means outstanding performance and the design-friendly look of wood. So go ahead and jump for joy. Acczent® is ready for action.



002 Light Beech WB
Solid Weld Rod 1294316
130 Sisal *

003 Medium Beech WB
Solid Weld Rod 1291205
TA7 Rusty Nail *



011 Cabreuva
Solid Weld Rod 1292207
TA7 Rusty Nail *

024 Wenge
Solid Weld Rod 1287344
WEN Wenge Wood *

* Suggested Tarkett colors for finishing borders (wall base). For our complete color offering, reference color guide in back.

The Solid and Multicolor Weld Rods listed are coordinating recommendations. Other color weld rods can be used for a variety of visual effects.

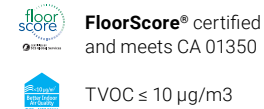

Recycled Content
Pre-consumer 40%
Rapidly Renewable 16%



roll width = 6'6"
nominal (2 m)

roll length = 88'7"
nominal (27 m)

thickness = .150"
nominal (3.8 mm)

adhesives pg. 196

A Acoustic | Sound Absorption

Veneto Acoustiflor®. Listen closely.

Fill your ears with peace and quiet. This linoleum super floor has a 1.3 mm polyurethane foam underlayer that reduces noise and adds thermal insulation and comfort. With timeless style, Veneto is available in six neutral colorways. And to top it all off, our proprietary xf2™ finish provides superior surface protection and easy maintenance. So every detail makes Veneto Acoustiflor® sound like a perfect choice.



601 Cloud Nine W
Solid Weld Rod 1751601
79 Bone White W *

611 Moonstone WB
Solid Weld Rod 1751313
461 Wicker WB *

625 Arizona Tan WB
Solid Weld Rod 1751625
49 Beige WB *

673 Comet WG
Solid Weld Rod 1751673
71 Storm Cloud CG *

684 Cascade CG
Solid Weld Rod 1751684
38 Pewter CG *

604 Carlsbad WG
Solid Weld Rod 1751604
29 Moon Rock WG *

* Suggested Tarkett colors for finishing borders (wall base). For our complete color offering, reference color guide in back.

The Solid and Multicolor Weld Rods listed are coordinating recommendations. Other color weld rods can be used for a variety of visual effects.

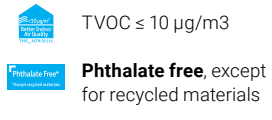
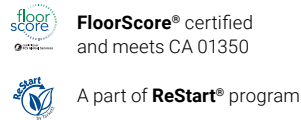

tile size = 24"x 24"
(610 mm x 610 mm nominal)
roll width = 6'6" nominal (2 m)

roll length = 76' nominal (23 m)
thickness = .080" nominal (2 mm)

adhesives pg. 196

Electrostatic Conductive Flooring

iQ™ Toro SC.
Gain control.

Concerned about conductivity? We've got you covered. iQ™ Toro SC has a low electrical resistance (104 to 106 ohms), protecting environments from damage by controlling and conducting static electricity. For a telecommunications center, operating room or explosives manufacturer, iQ Toro SC is a smart, safe choice with plenty of style. Select from 12 color options, by the roll or in 24" x 24" tiles.

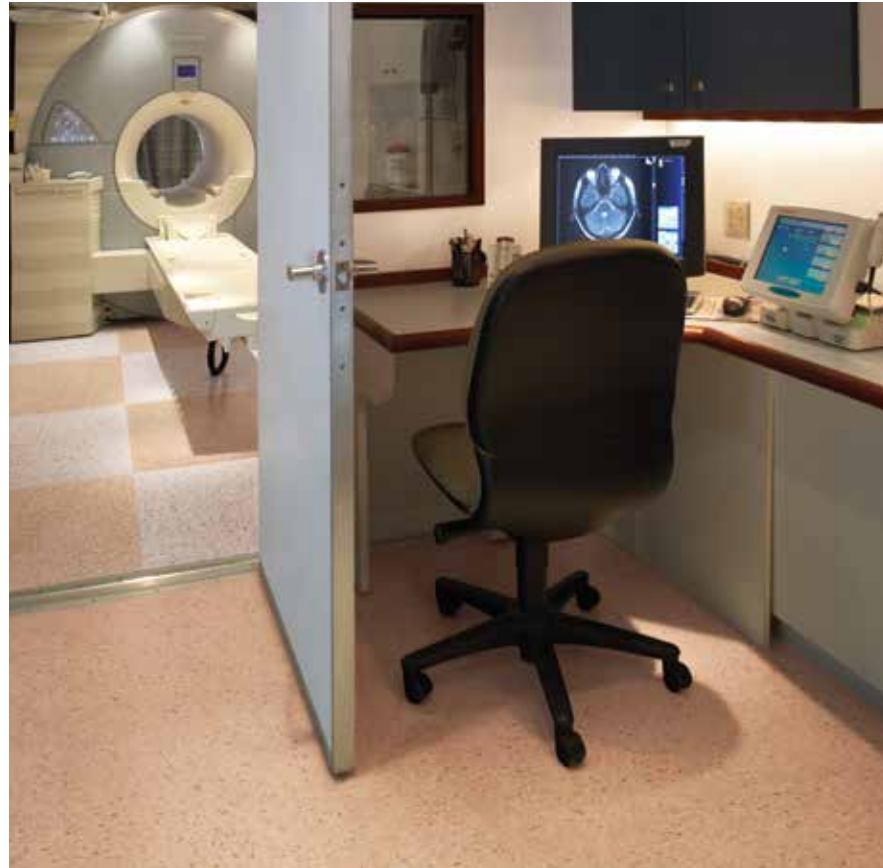

100 Tundra WG
Solid Weld Rod 1287322
Multicolor 1290054
27 Mist WG *

570 Raw Ivory W
Solid Weld Rod 1287531
Multicolor 1290025
11 Canvas WB *



572 Tapestry
Solid Weld Rod 1287438
Multicolor 1290039
146 Butternut *

103 Blackjack B
Solid Weld Rod 1292384
Multicolor 1290035
40 Black B *



104 Abalone WB
Solid Weld Rod 1288255
Multicolor 1290036
12 Hard Rock WB *

105 Amber Wave
Solid Weld Rod 1292372
Multicolor 1290031
130 Sisal *

573 Hot Ginger
Solid Weld Rod 1287059
Multicolor 1290042
130 Sisal *

107 Blue Belle
Solid Weld Rod 1291210
Multicolor 1290038
84 Blue Jeans *



574 Flannel Blanket CB
Solid Weld Rod 1287379
Multicolor 1290088
80 Fawn CB *

575 Old Bark
Solid Weld Rod 1287456
Multicolor 1290089
47 Brown *



576 Turf
Solid Weld Rod 1287309
Multicolor 1290078
190 Greege *

578 Sidewalk
Solid Weld Rod 1291216
Multicolor 1290026
38 Pewter CG *

* Suggested Tarkett colors for finishing borders (wall base).
For our complete color offering, reference color guide in back.

The Solid and Multicolor Weld Rods listed are coordinating recommendations.
Other color weld rods can be used for a variety of visual effects.

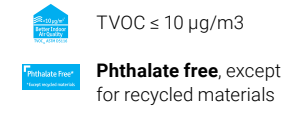
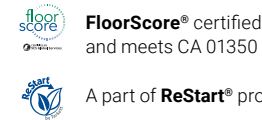

tile size = 24"x 24"
(610 mm x 610 mm nominal)
roll width = 6'6" nominal (2 m)

roll length = 76' nominal (23 m)
thickness = .080" nominal (2 mm)

adhesives pg. 196

Electrostatic | Static Dissipative



iQ™ Granit™ SD. Keep control.

Keeping static away from people and equipment is a priority that we take seriously. So we engineered a homogeneous resilient flooring that's permanently static dissipative. iQ™ Granit™ SD provides low electrical resistance (106 to 109 ohms) that lasts a lifetime. And by balancing function with the aesthetic of 12 varied colorways, this flooring can maintain safety, increase productivity, and best of all—provide peace of mind for all involved.



710 Full Moon WG
Solid Weld Rod 1287411
Multicolor 1290054
195 Ash WG *

719 Raw Ivory WB
Solid Weld Rod 1287256
Multicolor 1290025
11 Canvas WB *

715 Tapestry
Solid Weld Rod 1287416
Multicolor 1290039
34 Almond W *



713 Kettle Black B
Solid Weld Rod 1287414
Multicolor 1290035
40 Black B *

714 Misty WB
Solid Weld Rod 1287415
Multicolor 1290036
12 Hard Rock WB *

716 Kahlua
Solid Weld Rod 1287417
Multicolor 1290031
130 Sisal *



721 Hot Ginger
Solid Weld Rod 1287431
Multicolor 1290042
130 Sisal *

718 Cool Breeze
Solid Weld Rod 1287419
Multicolor 1290038
84 Blue Jeans *

722 Flannel Blanket CB
Solid Weld Rod 1287379
Multicolor 1290088
80 Fawn CB *



723 Old Bark
Solid Weld Rod 1287456
Multicolor 1290089
47 Brown *

724 Turf
Solid Weld Rod 1287499
Multicolor 1290078
190 Greege *

726 Sidewalk CG
Solid Weld Rod 1287394
Multicolor 1290026
38 Pewter CG *

* Suggested Tarkett colors for finishing borders (wall base).
For our complete color offering, reference color guide in back.

The Solid and Multicolor Weld Rods listed are coordinating recommendations.
Other color weld rods can be used for a variety of visual effects.

roll width = 6'6" nominal (2 m)

thickness = .080" nominal (2 mm)

adhesives pg. 196

roll length = 76' nominal (23 m)

 Slip Resistance | Safety

Granit™ Safe-T. Enjoy the journey.

One fall on a slippery, wet floor is one too many. So we developed Granit Safe-T. With aluminum granules dispersed throughout its construction, Granit™ Safe-T provides a lifetime of superior slip resistance, helping to keep both physical and financial costs down. And safe and sound passages nowhere but up.



roll width = 6'6" nominal (2 m)

thickness = .080" nominal (2 mm)

adhesives pg. 196

roll length = 76' nominal (23 m)



697 Yoga CG
Solid Weld Rod 1291811
Multicolor 1290028
38 Pewter CG *



691 Soft Fleece WB
Solid Weld Rod 1288255
Multicolor 1290036
49 Beige WB *



698 Homing Pigeon CG
Solid Weld Rod 1292383
Multicolor 1290021
23 Vapor Grey CG *



692 Acorn WB
Solid Weld Rod 1287407
Multicolor 1290023
130 Sisal *



690 Semolina
Solid Weld Rod 1287249
Multicolor 1290056
130 Sisal *



693 Hot Chocolate
Solid Weld Rod 1292375
Multicolor 1290046
33 Adobe Peach *



695 Blue Veranda
Solid Weld Rod 1291210
Multicolor 1290038
106 Skinny Dip *



696 Full Sail
Solid Weld Rod 1292379
Multicolor 1290041
84 Blue Jeans *



694 Acadia
Solid Weld Rod 1287332
Multicolor 1290059
TH1 Glenhaven *



699 Eclipse CG
Solid Weld Rod 1288327
Multicolor 1290027
71 Storm Cloud CG *



700 After Midnight B
Solid Weld Rod 1292384
Multicolor 1290035
40 Black B *

* Suggested Tarkett colors for finishing borders (wall base).
For our complete color offering, reference color guide in back.

The Solid and Multicolor Weld Rods listed are coordinating recommendations.
Other color weld rods can be used for a variety of visual effects.

Defiant Solids and speckled tile size = 24" x 24" (610 mm x 610 mm nominal)

Phthalate free

Marbleized™ tile size = 12" x 12" (305 mm x 305 mm nominal)

thickness = 1/8" (3.175 mm)
textures pg.29
adhesives pg. 196
chip details pg.209

Defiant™ Oil- and Grease-Resistant Rubber Tile and Stair Treads. Stand tough.

Engineered to work most anywhere petroleum products, animal fats or vegetable oils are present, Defiant™ defends. It meets ASTM specs for oil and grease resistance, providing your space with the best protection available. Plus, you'll get the performance, longevity and slip-resistance of rubber. With Defiant, balancing safety and efficiency is simple. Allowing you to create a more productive environment.

STANDARD SPECKLED COLORWAYS



STANDARD MARBLEIZED® COLORWAYS



SOLID COLOR TILES

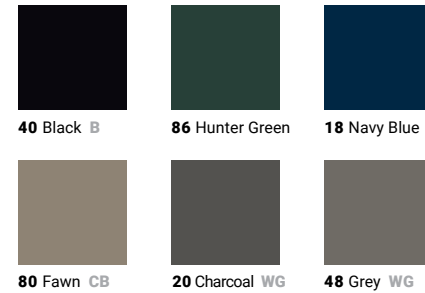

* Suggested Tarkett colors for finishing borders (wall base). For our complete color offering, reference color guide in back.

DEFIANT OIL- AND GREASE-RESISTANT RUBBER TILE				
Patterns	Textures	Product Code	Gauge	Size
Solids	Hammered	GRHRT-XXX	1/8" (3.175 mm)	24" x 24" Tile
	Raised Round	GRRT-XXX		
Marbleized	Hammered	GRHRTP-XXX	1/8" (3.175 mm)	12" x 12" Tile
Speckled	Hammered and Raised Round	GRHRTSP-XXX and GRRTSP-XXX	1/8" (3.175 mm)	24" x 24" Tile

AVAILABLE TEXTURES

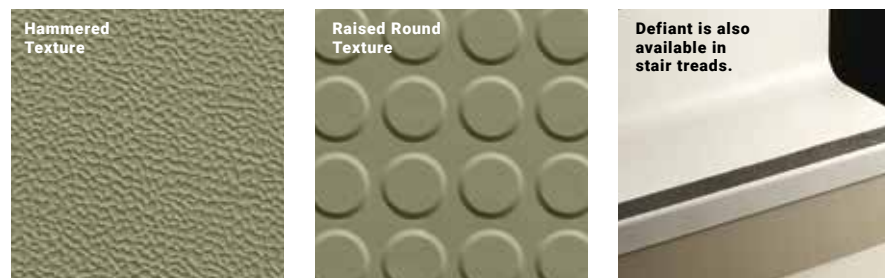

Meets or exceeds the following tests:

- ASTM D hardness > 85
- ASTM D 471 oil and grease resistance
- ASTM D 2047 slip resistance > 0.8
- ASTM D 3389 abrasion resistance
- ASTM E 648 – class 1
- ASTM E 662 smoke < 450; passes
- ASTM F 970 static load < 0.005"
- ASTM F 1344 rubber floor tile
- ASTM F 1514 resistance to heat
- ASTM F 2199 dimensional stability

TERRA-TURF

A part of **ReStart**® program

tile size = 12" x 12" (305 mm x 305 mm nominal)
roll width = 12" nominal (305 mm)

Recycled Content
Pre-consumer 90%
adhesives pg. 196

Terra-Turf® Recycled Tile. Take charge.

Rough and rugged Terra-Turf® is made from post-consumer recycled tires, with the traction and grip that's required on ramps and entryways—both inside and out. With lasting performance and sustainability, Terra-Turf® won't shrink or delaminate.

Available in Natural Black/Brown



CLEAN PATH

NSF-140 certified platinum (UL)

A part of **ReStart**® program

tile size = 24" x 24" (610 mm x 610 mm nominal)

pile height = .187" (4.8 mm)

Recycled Content
Pre-consumer 30.8%

adhesives pg. 196

Clean Path Entrance Barrier Modular Tile. Endure.

Walk all over it. That's what Clean Path is counting on. Offering advanced technology disguised as carpet, Clean Path is available in two standard colors to hide dirt and debris. This walk-off modular tile stands its ground to protect all kinds of entryways. From hospitals to schools and office buildings to restaurants, Clean Path traps dirt and moisture to protect your other floors—and the people who walk on them.

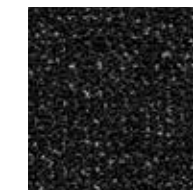

QA1 Black

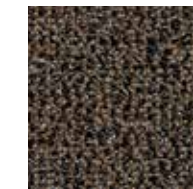

QA2 Brown



* Suggested Tarkett colors for finishing borders (wall base). For our complete color offering, reference color guide in back.

Safe-T-First®

EMERGENCY EGRESS ROUTING SYSTEM

Find
your way.

In critical moments when every second counts, safe evacuation is top priority. With our patented photoluminescent technology, the Safe-T-First® System is made with non-toxic, inorganic, strontium-aluminate crystals. They absorb and store light energy, then release it in darkness—without depending on electricity or batteries. The system's bright, long-lasting pigments are incorporated into stair treads, wall base and other accessories, helping light the way through power failures and other emergency situations.



Safe-T-First® Photoluminescent Egress Routing System. Lead the way.

Hero training starts here. Help individuals find their way out of a building in total darkness—and emergency personnel find their way in. The Safe-T-First® System protects from injury, disorientation and panic, and may ultimately save lives. The patented luminescence technology provides a lighted path low to the ground. Meet the challenges of safety and welfare head-on with the innovative Safe-T-First System.

An innovative concept in safety

Safe-T-First's photoluminescence is the result of a patented technology that incorporates bright, long-lasting pigments into Tarkett stair treads, traditional wall base and other items. This unique technology utilizes photoluminescent crystals that are inert, nontoxic and free of radioactivity.

APPLICATIONS

- commercial
- institutional
- governmental
- theaters

FLOORING SYSTEMS

- rubber and vinyl stair treads
- vinyl stair nosings
- traditional wall base
- tactile warning system
- handrail covers
- corner bumper guards

ADA COMPLIANT MARKING INDICATORS

- tape
- guidance strips



Carpet Cove Cap



Hand Rail Cover

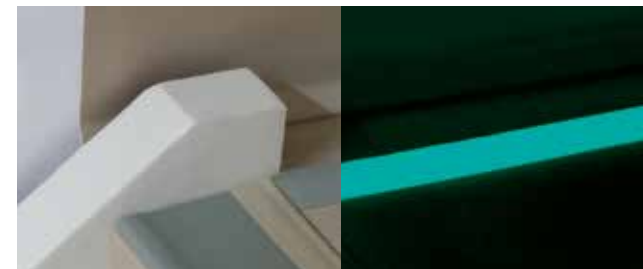

1" Feature Strip | Stair Nosing



Corner Bumper Guide | Wall Base



Feature Strip

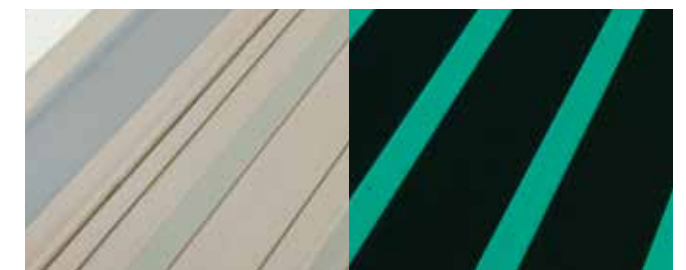

Tactile Warning Strip



Safe-T-First® Recommended Color Palette

These colors are a balanced palette of neutrals, which work well with the green cast of the extruded photoluminescent striping, as well as the traditional yellow tape. This carefully selected palette balances superior performance with superior looks.



Other Standard Colors Available with Safe-T-First®

The remaining ColorMatch® colors are also available as standard colors, in Safe-T-First.



Color Foundations™ is our commitment to always have representation across six key neutral palettes.

We've identified Color Foundations™ neutrals in the following way: WB (warm beige), CB (cool beige), WG (warm grey), CG (cool grey), B (black), W (white).

* These colors can be used in Safe-T-First Rubber Treads for Visually Impaired (VI) installations.

+ These colors can be used in Safe-T-First Vinyl Treads & Nosings for Visually Impaired (VI) installations.

All colors shown on this page, including chips and photographs, approximate the actual flooring colors as accurately as possible.



Safe-T-First® System

STF integrates photoluminescent technology into color- and design-coordinated resilient flooring products, allowing the space to look well-designed, in addition to providing safe passage. Available in 36 ColorMatch® colors that coordinate through all Tarkett flooring solutions, STF features low maintenance, highly durable surface finishes that diminish the use of water, chemicals and energy. The system's long life cycle and low maintenance requirements combine industry-leading safety, durability and aesthetic features.



* Note: For the Safe-T-First products which have the "green" photoluminescent striping, there may be slight variations in the green color from batch to batch, due to the inherent variation in the natural photoluminescent mineral (non-toxic strontium aluminate).



Rubber Stair Treads



PVIRH-XX-RD | Round Pattern - Square Nose
PVIRH-XX-SQ | Square Pattern - Square Nose
PVIRTR-XX-RD | Rubber Tread & Riser - Round Pattern - Square Nose
PVIRTR-XX-SQ | Rubber Tread & Riser - Square Pattern - Square Nose
PVIHTR-XX | Rubber Tread & Riser - Hammered Pattern - Square Nose

Vinyl Stair Treads

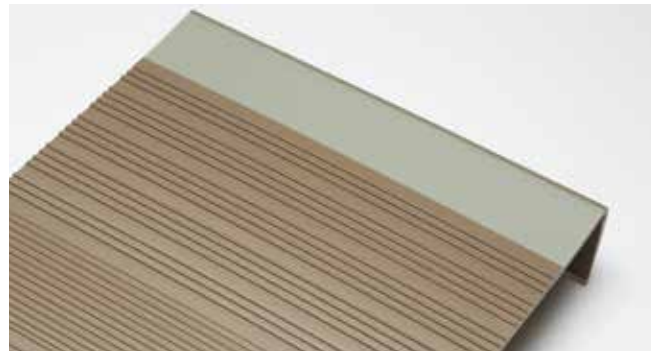

PVIHDN-XX-SQ | Coextruded 2" Strip - Square Nose

Vinyl Stair Nosings



PVITSNN-XX | Top Set Stair Nosing
PVIRCNN-XX-A | Undercut Carpet
PVIRCNN-XX-B | Heavy Duty Overlap Lip
PVIRCN-XX-B2 | Heavy Duty Overlap Lip with 2" Tape
PVIVCDN-XX | Double Undercut Nosing

Tactile Warning Strip

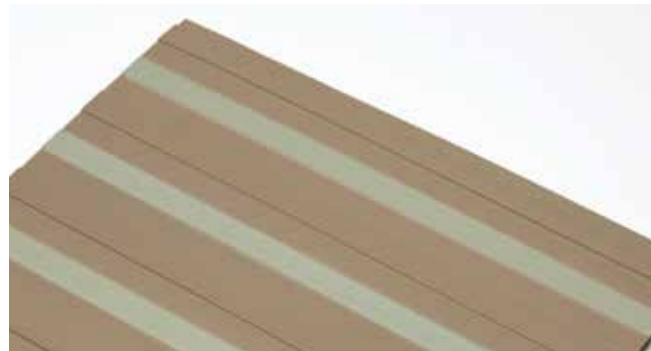

PTWN-XX

Wall Base | 4", 6"



PDCN-XX-4"x4' | with 1" PL Strip
PDCN-XX-4" x 120' | with 1" PL Strip

PDCN-XX-6"x4' | with 1" PL Strip
PDCN-XX-6"x100' | with 1" PL Strip

Hand Rail Cover



PHCN-XX

Corner Guards



PVBGN-XX-D-4' | lengths
PVBGN-XX-D-8' | lengths

Feature Strip



PVFSN-99-1" | 1" Feature Strip

Signage



P43867F
 Man Right Sign - Self-adhesive

P42945F
 Man Left Sign - Self-adhesive

P60204
 Door Handle Backing Sticker - Self-adhesive

Tapes



P40708
 1" Plain Tape

P44151
 1" Warning Tape with Black Diagonal Stripe

Like all Tarkett products, Safe-T-First is designed to respect natural resources, contribute to people-friendly spaces, and build a circular economy that creates a healthier, more prosperous future for all.

Safe-T-First is developed to meet sustainability objectives through better raw materials, resource stewardship, developing people friendly spaces and recycling/reusing.

For additional samples or information on Tarkett's full line of flooring and finishing accessories, please visit tarkettna.com or contact the sample department at 800.899.8916.



Stairwell Management

The right stairwell management system improves both the safety and appearance of these critical spaces, helping reduce risk and improve mobility from top to bottom.

162
Stairwell Design

165
Striping Solutions for
the Visually Impaired

167
Vinyl Stair Treads

164
Rubber Stair Treads
with Integrated Riser

166
Standard Rubber Stair
Treads

168
Stairwell Accessories

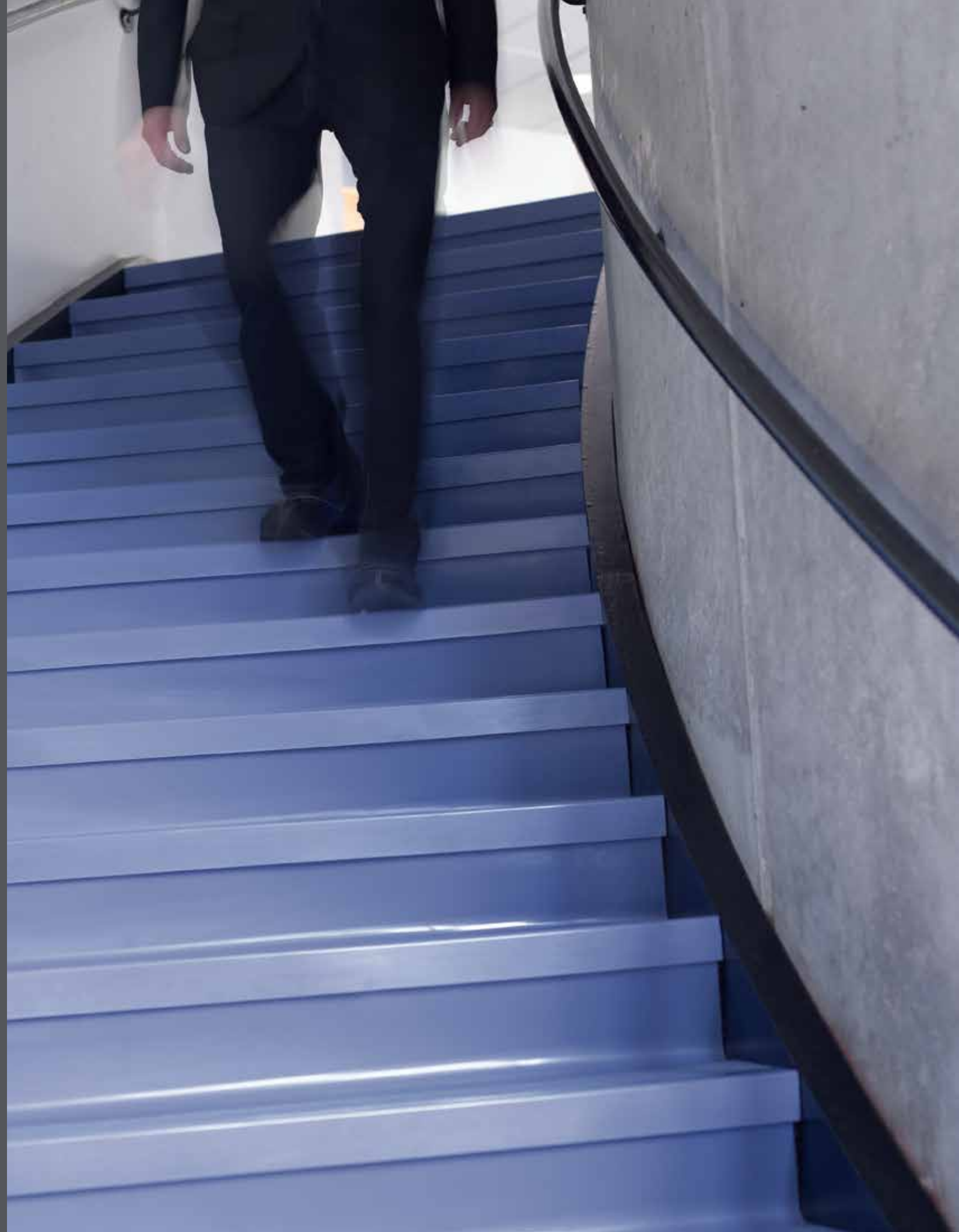

True flooring solutions improve every aspect of the experience, from aesthetics to safety and installation to maintenance. So Tarkett has made significant improvements to the design of its rubber stair treads that will minimize the time and cost of installation. Our new Angle Fit™ angled noses are available on all rubber treads—with or without risers—making every installation faster, easier and safer.

Well-rounded solutions.



STAIR NOSE

New angled stair nose returns to the step, allowing it to overlap the riser and eliminate time-consuming cuts.

NO CAULK

If stairs are in good condition, no nose caulk is required.

EASY RISER

The riser's thickness is reduced at the top, allowing it to slip easily below the stair nose.

SAFETY

Slip-resistant rubber treads are available in a variety of colors, textures and safety inserts for the visually impaired.

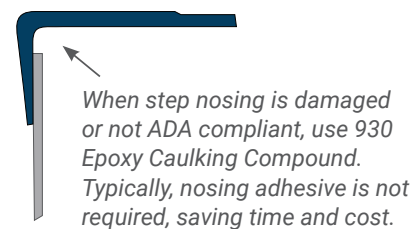
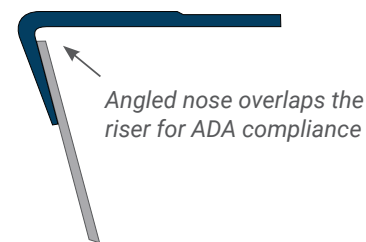

Shortened risers provide less material to trim and less waste on the job site.

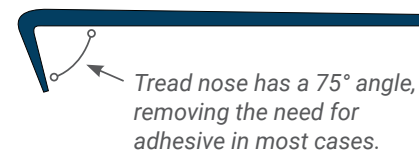

Thinner risers are easier to trim and slip below overlapping stair noses

One step at a time

The right stairwell management system improves both the safety and appearance of these critical spaces, helping reduce risk and improve mobility from top to bottom. With thousands of possible combinations, Tarkett's comprehensive stairwell management system provides no shortage of options. Choose between rubber and vinyl constructions to balance the needs of every project.

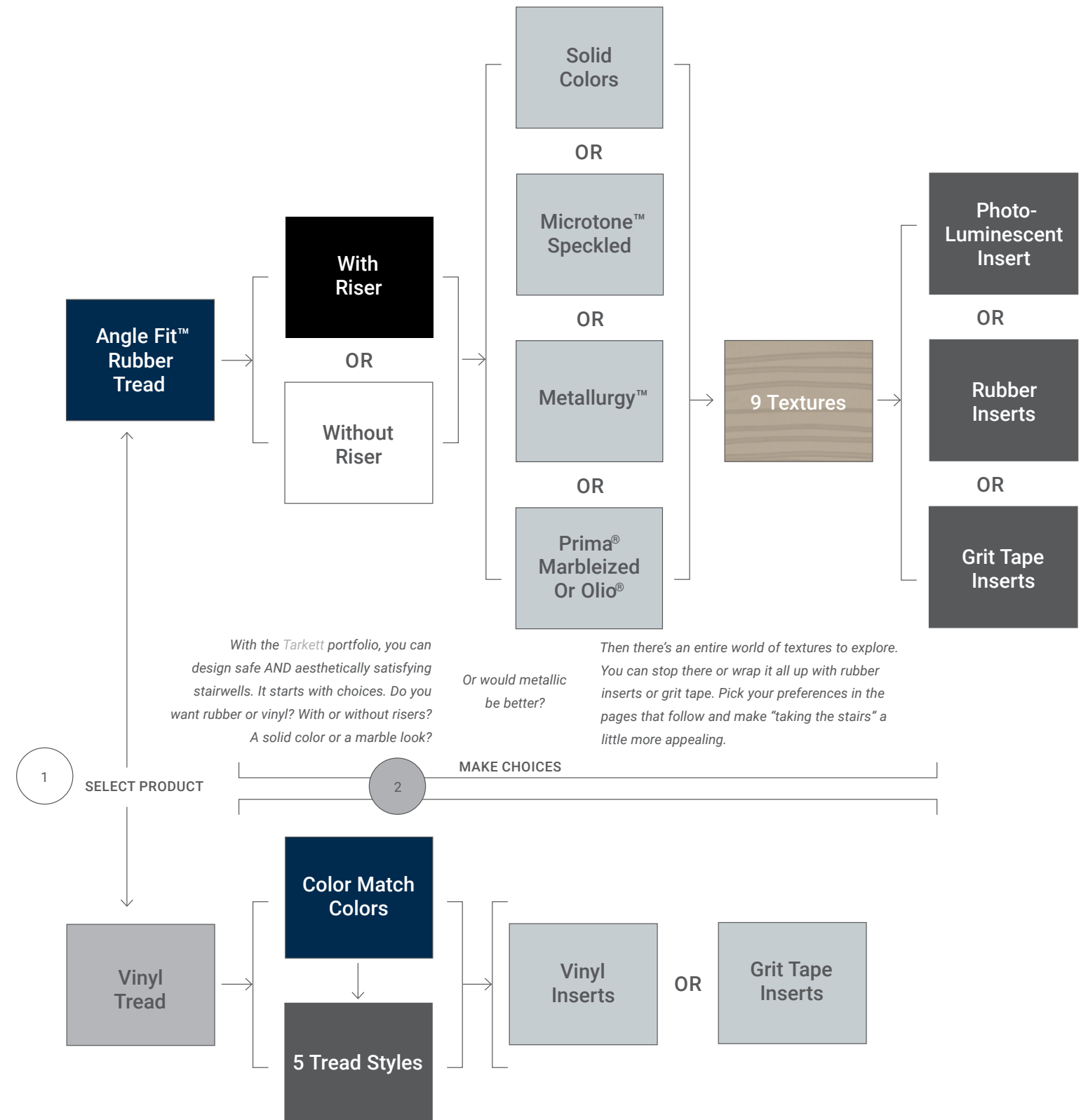

Angle Fit™ Rubber Stair Treads with Integrated Riser

<p>Rubber Tread with Integrated Riser</p> <p>Raised Round Tread/Riser (RNRDTR)</p> <p>Available in: S, B, Z</p>	<p>Rubber Tread with Integrated Riser for the Visually Impaired</p> <p>Raised Round Tread/Riser Visually Impaired (VIRNRDTR)</p> <p>Available in: S, B, Z, +</p>
<p>Raised Square Tread/Riser (RNSQTR)</p> <p>Raised Square Tread/Riser (RNSQTR)</p> <p>Available in: S, B, Z</p>	<p>Raised Square Tread/Riser Visually Impaired (VIRNSQTR)</p> <p>Raised Square Tread/Riser Visually Impaired (VIRNSQTR)</p> <p>Available in: S, B, Z, +</p>
<p>Hammered Tread/Riser (HNTR)</p> <p>Hammered Tread/Riser (HNTR)</p> <p>Available in: S, B, M, Z</p>	<p>Hammered Tread/Riser Visually Impaired (VIHNTR)</p> <p>Hammered Tread/Riser Visually Impaired (VIHNTR)</p> <p>Available in: S, B, M, Z, +</p>
<p>Bamboo Tread/Riser (BMNTR)</p> <p>Bamboo Tread/Riser (BMNTR)</p> <p>Available in: S, B, X</p>	<p>Bamboo Tread/Riser Visually Impaired (VIBMTR)</p> <p>Bamboo Tread/Riser Visually Impaired (VIBMTR)</p> <p>Available in: S, B, X, +</p>
<p>Cubis Tread/Riser (CUBTR)</p> <p>Cubis Tread/Riser (CUBTR)</p> <p>Available in: S, B, X, *</p>	<p>Cubis Tread/Riser Visually Impaired (VICUBTR)</p> <p>Cubis Tread/Riser Visually Impaired (VICUBTR)</p> <p>Available in: S, B, X, *, +</p>
<p>Fast Lane Tread/Riser (CFLNTR)</p> <p>Fast Lane Tread/Riser (CFLNTR)</p> <p>Available in: S, B, X, *</p>	<p>Fast Lane Tread/Riser Visually Impaired (VICFLNTR)</p> <p>Fast Lane Tread/Riser Visually Impaired (VICFLNTR)</p> <p>Available in: S, B, X, *, +</p>
<p>Diamond Tread/Riser (CNNTR)</p> <p>Diamond Tread/Riser (CNNTR)</p> <p>Available in: S, B, X, *</p>	<p>Diamond Tread/Riser Visually Impaired (VICNNTR)</p> <p>Diamond Tread/Riser Visually Impaired (VICNNTR)</p> <p>Available in: S, B, X, *, +</p>
<p>Rice Paper Tread/Riser (FRPANTR)</p> <p>Rice Paper Tread/Riser (FRPANTR)</p> <p>Available in: S, B, X, *</p>	<p>Rice Paper Tread/Riser Visually Impaired (VIFRPANTR)</p> <p>Rice Paper Tread/Riser Visually Impaired (VIFRPANTR)</p> <p>Available in: S, B, X, *, +</p>

Angle Fit Rubber Stair Treads

Visually Impaired Color Solutions +

Grit Tape Color

- Black
- Brown
- Grey
- Tan
- Yellow
- White

Solid Color Rubber Insert

- 40 Black
- 47 Brown
- 49 Beige
- 55 Silver Grey
- 85 Burgundy

Landing Tile
All tiles available in 24" x 24". Smooth is also available in 12" x 12".

Smooth (C) Diamond (CN)

All tile textures can be used as landing tile.

Black: Grit tape contrasts with colors 01, 12, 21, 24, 27, 28, 29, 31, 32, 38, 41, 48, 55, 58, 59, 62, 71, 84, 106, 121, 129, 150, 151, 163, 190, 192, 280, 281, 282, 293, AGM, BRL, BRM, CGL, CGM, CPM, WGL, WGM, LA2, LA3, LA5, LA6, LA8, LB4, LB6, LC8, LC1, LC2, LC3, LC4, LC5, LC6, LC7, LD1, LD2, LD4, LD5, LD7, LE1, LE3, LE7, LE8, LE9, LF9, LG1, LG3, LG8, LH3, LH7, LJ1, LJ2, LJ3, LJ5, LJ7, LJ8, LJ9, LK1, TB6, TG2, TG3, TG5, TG6, TG7, TG8, TH1

Brown: 09, 11, 22, 33, 34, 42, 45, 49, 68, 80, 130, 469, LA1, LA9, LB2, LB3, LC9, LD8, LD9, LE2, LE4, LE5, LE8, LE9, LF1, LF3, LF4, LG4, LG7, LG9, LH2, LH4

Grey: 15, 18, 20, 40, 72, 73, 85, 86, 92, 162, 168, CGD, LB5, LB8, LB9, LD3, LE6, LF5, LG2, LG6, LH7, LH9, TG1, TG4, WGD

Tan: 47, 63, 76, 101, 113, 132, 149, 167, 284, 548, 725, BRD, CPD, LA7, LB1, LD6, TG9, TH2, TH3

Yellow: 70, LB7, LF7, LJ4

White Grit Tape available by special order
Photoluminescent Tape available

40 Black: Insert contrasts with colors 01, 12, 21, 24, 27, 28, 29, 31, 32, 38, 41, 48, 55, 58, 59, 62, 71, 84, 106, 121, 129, 134, 150, 151, 163, 190, 192, 280, 281, 282, 293, 486, AGM, BRL, BRM, CGL, CGM, CPM, WGL, WGM, LA2, LA3, LA5, LA6, LA8, LB4, LB6, LC8, LC1, LC2, LC3, LC4, LC5, LC6, LC7, LD1, LD2, LD4, LD5, LD7, LE1, LE3, LE7, LE8, LE9, LG1, LG3, LG8, LH3, LH7, LJ1, LJ2, LJ3, LJ5, LJ7, LJ8, LJ9, LK1, TB6, TG2, TG3, TG5, TG6, TG7, TG8, TH1

47 Brown: 09, 11, 22, 33, 34, 42, 45, 49, 68, 80, 130, 469, LA1, LA9, LB2, LB3, LC9, LD8, LD9, LE2, LE4, LE5, LE8, LE9, LF1, LF3, LF4, LG4, LG7, LG9, LH2, LH4

55 Silver Grey: 15, 18, 20, 40, 72, 73, 85, 86, 92, 162, 168, CGD, LB5, LB8, LB9, LD3, LE6, LF5, LG2, LG6, LH7, LH9, TG1, TG4, WGD

49 Beige: 47, 63, 76, 101, 113, 132, 149, 167, 284, 548, 725, BRD, CPD, LA7, LB1, LD6, TG9, TH2, TH3

COLOR PALETTE AVAILABILITY

- S = Available in Solid Color Palette
- B = MicroTone™ Speckled colorways
- M = Can be ordered in Metallurgy colorways
- ▲ = Can be special ordered in Prima® Marbleized and Prima Olio® colorways. Visit tarkettna.com. Minimums may apply
- ★ = Can be special ordered in Speckled colorways.

Stair Tread Insert Color Combinations

+ = See chart above for recommended contrasting color combinations.

Sizes/Available Lengths

- X = 3'⁴, 3.5'⁴, 4', 4.5', 5', 6'
- Y = 3'⁴, 3.5'⁴, 4', 4.5', 5', 6', 7', 8'
- Z = 3'⁴, 3.5'⁴, 4', 4.5', 5', 6', 7', 8', 9'

△ Denotes special order.

Enlarged Textures Below

Indoor Air Quality
Low Emitting materials EQ 4.3
FloorScore™ certified and meets CA 01350

Angle Fit Rubber Stair Treads Textures

Raised Round Raised Square Hammered Bamboo Cubis

Fast Lane Diamond Rice Paper Smooth



Angle Fit™ Rubber Stair Treads without Integrated Riser

Standard Rubber Stair Treads

Bamboo Tread (BMNT)

 S ▲ ★ X

Cubis Tread (CUBT)

 S ▲ ★ X

Fast Lane Tread (CFLNT)

 S ▲ ★ X

Raised Round Tread (RNRD)

 S ▲ ★ Y

Raised Square Tread (RNSQ)

 S ▲ ★ X

Hammered Tread (HMNT) 12 1/4" deep (HMNTD) 14" deep

 S M ▲ Z

Service Weight Smooth Tread (SN)

 S X

Diamond Tread (CNN)

 S ▲ ★ X

Rice Paper Tread (FRPANT)

 S ▲ ★ X

Service Weight Safe-T-Grip Tread (SAN)

 S X

Standard Rubber Stair Treads for the Visually Impaired

Bamboo Tread Visually Impaired (VIBMNT)

 S ▲ + X

Cubis Tread Visually Impaired (VICUBT)

 S ▲ + X

Fast Lane Tread Visually Impaired (VICFLNT)

 S ▲ + X

Raised Round Tread without Riser Visually Impaired (VIRNRD)

 S ▲ ★ + Y

Raised Square Tread without Riser Visually Impaired (VIRSQ)

 S ▲ + X

Hammered Tread without Riser Visually Impaired (VIHMNT) 12 1/4" deep (VIHMNTD) 14" deep

 S M ▲ + Z

Service Weight Smooth Tread Visually Impaired (VISN)

 S + X

Diamond Tread Visually Impaired (VICNN)

 S ▲ + X

Rice Paper Tread Visually Impaired (VIFRPANT)

 S ▲ + X

Vinyl Stair Treads

Vinyl Treads

Heavy Duty Square Nose (HD)

 C W

Safe-T-Rib® Square Nose (HT)

 C W

Safe-T-Rib Round Nose (HT)

 C W

Service Weight Square Nose (ST)

 C W

Service Weight Round Nose (ST)

 C W

Vinyl Treads for the Visually Impaired

Heavy Duty Square Nose Visually Impaired (VIHD)

 C X W

Safe-T-Rib Square Nose Visually Impaired (VIHT)

 C + W

Safe-T-Rib Round Nose Visually Impaired (VIHT)

 C + W

Safe-T-Grip Square Nose Visually Impaired (VIVG)

 C + W

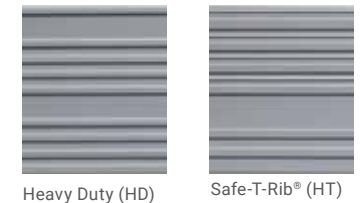

Visually Impaired Color Solutions

Grit Tape Color +

- Black
- Brown
- Grey
- Tan
- Yellow
- White

Black Grit Tape contrasts with colors 01, 21, 24, 28, 29, 31, 32, 38, 48, 55, 58, 71, 129, 150
Brown Grit Tape contrasts with colors 09, 11, 22, 34, 42, 45, 49, 80, 130
Grey Grit Tape contrasts with colors 18, 20, 40, 85, 86, 92
Tan Grit Tape contrasts with colors 44, 47, 63, 76, 132, 167, 283
Yellow Grit Tape available by special order
White Grit Tape available by special order

Co-Extruded Vinyl insert X

- 40 Black
- 47 Brown
- 49 Beige
- 55 Silver Grey

40 Black Insert contrasts with colors 01, 21, 24, 28, 29, 31, 32, 38, 48, 55, 58, 59, 71, 129, 150
47 Brown Insert contrasts with colors 09, 11, 22, 34, 42, 45, 49, 80, 130
49 Beige Insert contrasts with colors 44, 47, 63, 76, 132, 167, 283
55 Silver Grey Insert contrasts with colors 18, 20, 40, 85, 86, 92

Rubber Landing Tile for Use with Vinyl Stair Treads

Tiles available in 24" x 24" and in 12" x 12".
Smooth (C)
 S ▲

All tile textures can be used as landing tile.



COLOR PALETTE AVAILABILITY

C = ColorMatch Palette

Stair Tread Insert Color Combinations

- +** = See chart above for recommended contrasting color combinations.
- X** = See chart above for recommended contrasting color combinations.
- S** = Available in Solid Color Palette
- ▲** = Can be specially ordered in Prima® Marbleized™ and Prima® Olio® colorways. Visit tarkettna.com. Minimums may apply.

Sizes / Available Lengths

W = 3', 3.5', 4', 6', 8', 12'

How to Order: Product Code – Color Number – Length – Nose Type
 (Example: VIHD – 18 – 4' SQ Navy Blue)(Example: S/B VIHD – 18 – 4' SQ)





Stairwell Accessories

Move up.

Proper stairwell design is crucial to the safety and functionality of any space. That's why all our stairwell components—from nosings to treads to striping solutions—are designed to reduce slip/fall accidents and work seamlessly with the other elements in the space, giving upward mobility a whole new meaning.



Color Palette Availability

- C** = ColorMatch
Reference color guide in back.
- D** = Available in Metallic Colors
Reference color guide in back.
- ▲** = Can be specially ordered in Prima®
Marbleized™ and Prima® Olio® colorways.
Visit tarkettna.com. See page 49 for
details. Minimums may apply.
- *** = Also available in 50 White.
- ✓** = Available without contrasting strip.
- +** = See chart on page 167 for
contrasting Grit Tape colors.
- ✖** = See chart on page 156 for
contrasting solid insert colors.

adhesives pg. 196

RUBBER STRINGERS AND RISERS

ITEM	SIZE	GAUGE
Stringers Solid Color Stringers Marbleized	10' x 6'	.080"
	10' x 6'	1/8"
Risers	6" x 4"	1/8"
	6" x 100**	1/8"
	7" x 4"	1/8"
	7" x 5"	1/8"
	7" x 6"	1/8"

Stringers and risers are available in solid colors. Speckled, Prima® Marbleized™ and Olio® are available by special order.

** Not available in Speckled or Marbleized.

VINYL STRINGERS AND RISERS

ITEM	SIZE	GAUGE
Stringers	10' x 50'	.080"
Risers	6" x 4"	.080"
	6" x 120'	.080"
	7" x 4"	.080"
	7" x 50'	.080"

Vinyl stringers and risers are available to coordinate with vinyl or rubber treads in your choice of more than 30 colors including ColorMatch®.

TACTILE WARNING SURFACE

Reduce potential accidents by alerting the Visually Impaired that they're approaching hazardous areas. Detectable tactile warning surface meets ANSI A117.1-1986 design requirements and is available in more than 30 attractive solid colors. Permanently co-extruded contrasting striping can also be ordered.

FLEXIBLE VINYL STAIR NOSINGS FOR THE VISUALLY IMPAIRED

VIRCN-XX-B

1/8" material w/lip or 3/16" w/o lip. 2" co-extruded visually impaired strip.

C ✖ ✓ ✖

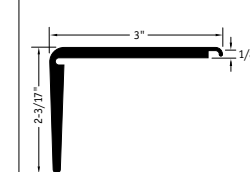

VIRCN-XX-B2

1/8" material. 1/8" visually impaired Grit Tape insert.

C +

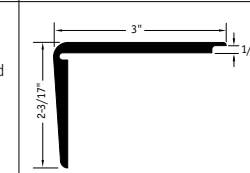

VITSN-XX

Top set with 2" co-extruded visually impaired strip.

C ✖

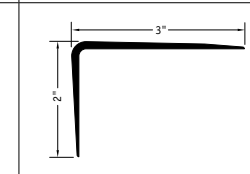

VIRCN-XX-A

1/4" or 5/16" material. 2" co-extruded visually impaired strip.

C ✖ ✓ ✖

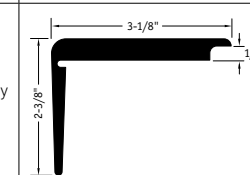

VIVCD-XX

1/4" or 5/16" material for step and riser. 2" co-extruded visually impaired strip.

C ✖ ✓ ✖

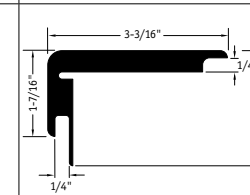

SLIM LINE STAIR NOSINGS

SLN-XX-A

1/4" material on step to 1/4" material on riser.

C **D**

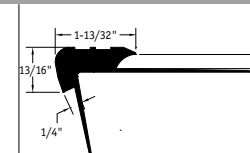

SLN-XX-B

7/32" material on step to 1/4" material on riser.

C **D**

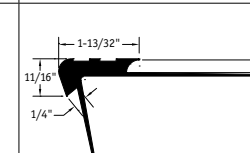

SLN-XX-C

3/8" material on step to 3/8" material on riser.

C **D**

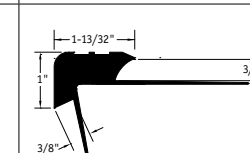

FLEXIBLE VINYL STAIR NOSINGS

Take steps to protect flooring materials from wear in stair and landing applications. Choose from 16 popular nosing profiles in the ColorMatch system or we can custom-match colors for your project. Slim line stair nosings are also available in metallic colors. To meet stringent accessibility requirements, choose profiles with contrasting color inserts for the Visually Impaired.

SOLID COLOR FLEXIBLE VINYL STAIR NOSINGS

VDL-XX-RD

1/8" material.

C

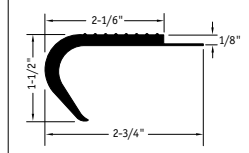

VDL-XX-SQ

1/8" material.

C

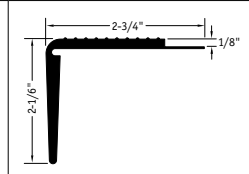

RCN-XX-B

1/8" material w/lip or 3/16" w/o lip.

C

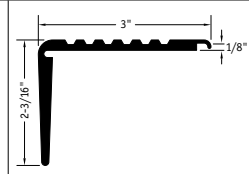

DTN-XX

Top set stair nosing for residential use.

C

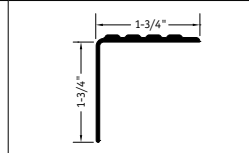

RCN-XX-A

1/4" or 5/16" material.

C ✖

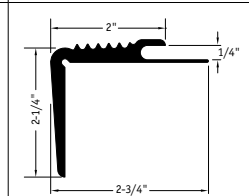

VCD-XX

1/4" or 5/16" material on step and riser.

C

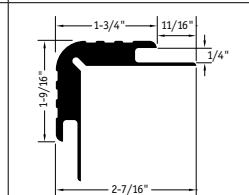

SVCD-XX-A

3/8" material on step and riser.

C

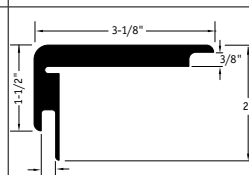

SRCN-XX-C

3/8" material on step.

C

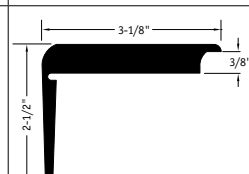



Finishing Borders

With the most comprehensive collection of finishing borders in the industry, we're covering all the details that make a space complete.

172
Millwork®
Wall Finishing System

178
Millwork® Masquerade®
Wall Base

182
Traditional
Vinyl + Rubber
Wall Base
BaseWorks®
TightLock® Wall Base

176
Perceptions®
Designer Wall Base

180
Wall Art™
Decorative Wall Base

183
Thermoset
Rubber Wall Base

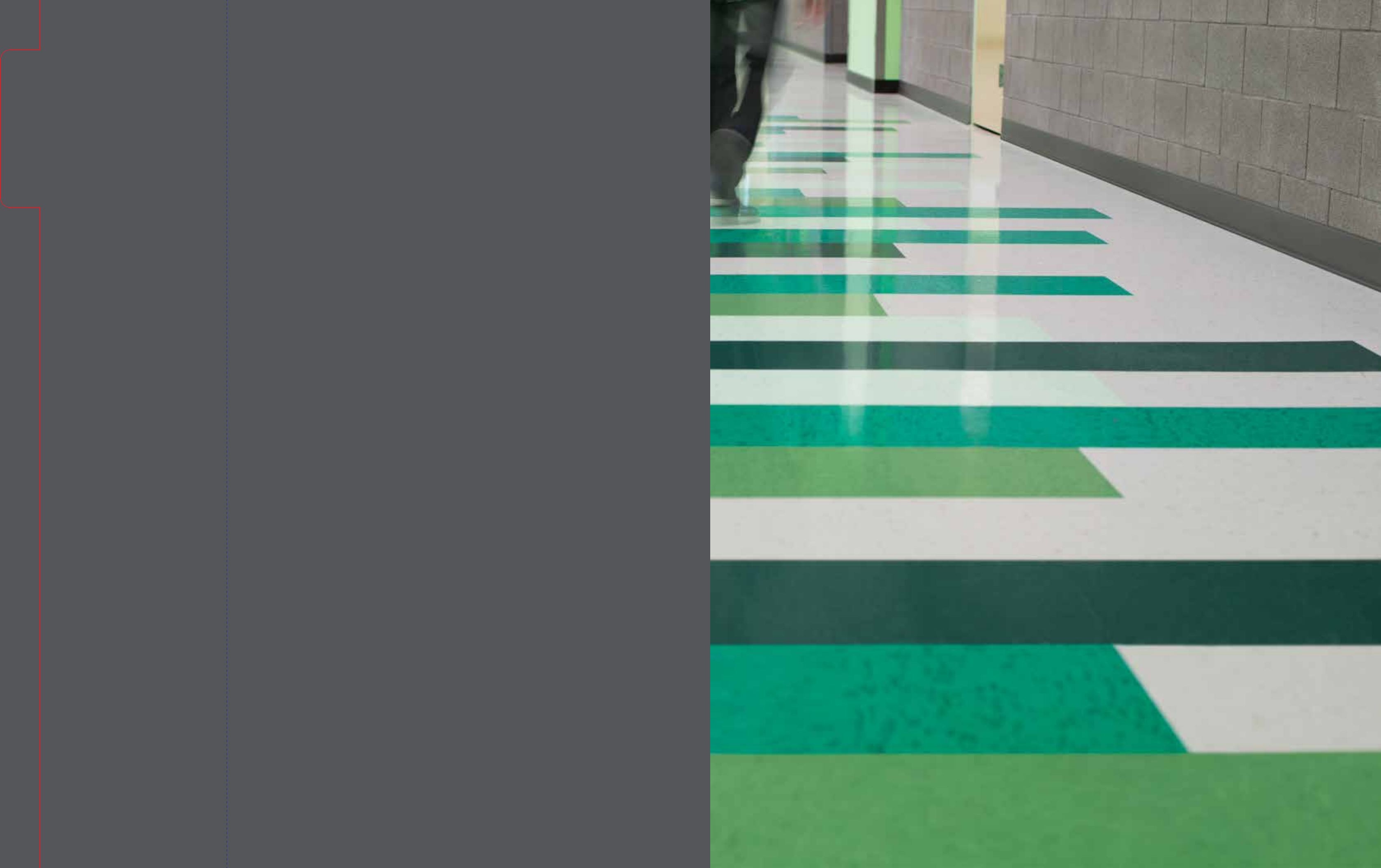

Millwork®

WALL FINISHING SYSTEM

Be exceptional.

With the look of finely milled wood, the Millwork® Wall Finishing System adds rich architectural detail—at roughly half the installed cost of wood trim and half the installation time. And since it will never require touch-up or repainting, Millwork continues to save time and money throughout its lifetime.

Luxury, simplified.

Installing wood trim takes several labor-intensive steps. From measuring each cut and mitering corners, to nailing, filling, painting and finishing. The work continues each time a section is chipped or scratched. Instead, we bring you the same rich look and longer-lasting performance in half the time and cost. The Millwork Wall Finishing System installs easily—even around corners, curves and irregular surfaces—with flexible 8-foot lengths and one-piece corner guards that adhere directly to the wall. Unlike real wood, it won't splinter, chip or absorb moisture and humidity. But with its glossy finish and crisp edges, no one will ever know the difference.

INSTALLATION STEPS: REAL WOOD VS. MILLWORK®

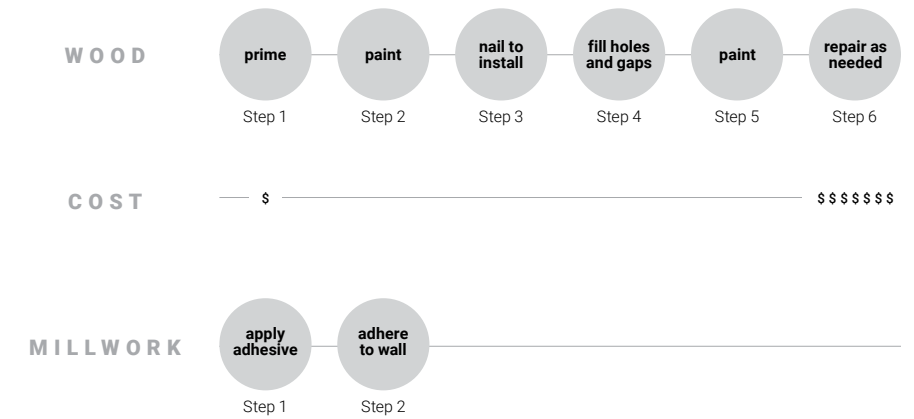

All covered.

The Millwork® Wall Finishing System eliminates concerns of mismatched wood or color variation. With more than 20 coordinating elements, Tarkett can help you cover your bases completely and

consistently from batch to batch and year to year. Choose from contoured wall base profiles, a chair rail profiles, a corner guard, self-stick quarter round and shoe moulding.

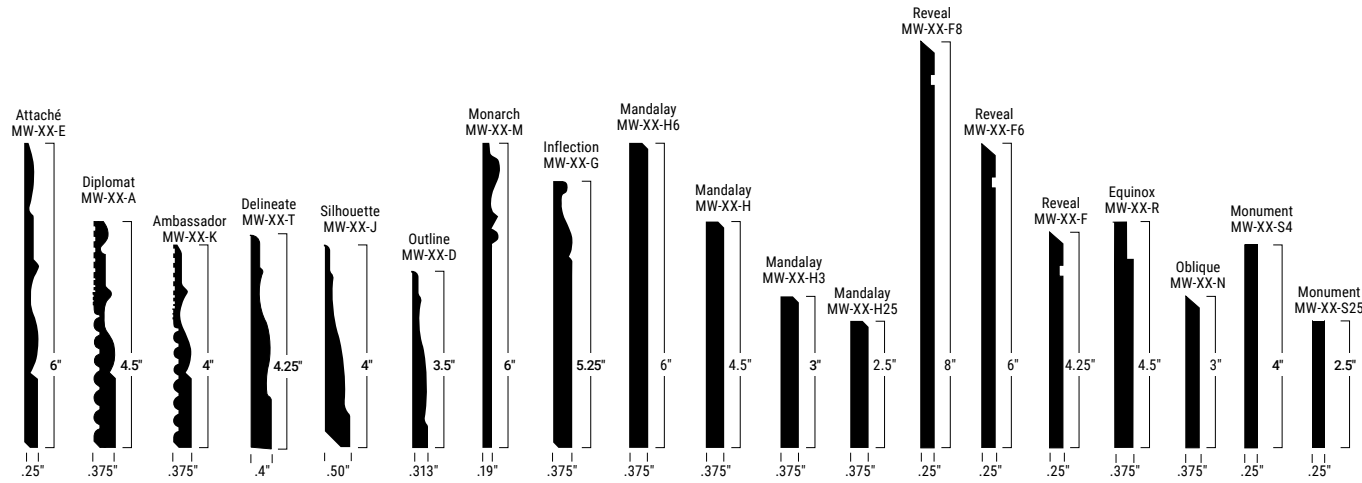

All Millwork profiles in wall base, chair rails and corner guard are available in standard 8' lengths.

MILLWORK® CHAIR RAIL



Rampart®
CHR-XX-C
Recommended Millwork Masquerade™ profile

MILLWORK CORNER GUARD



Millwork Corner Guard
VBG-XX-C

MILLWORK ACCESSORIES



Quarter Round
QTR-XX-A
QTR-XX-D



Shoe Moulding
SHU-XX-A

color palette availability

Millwork is available in all solid colors plus unfinished.

M = Available in Masquerade Palette
W = Available in Wall Art Palette



Attaché
MW-XX-E



Diplomat®
MW-XX-A



Delineate
MW-XX-T



Silhouette®
MW-XX-J



Outline®
MW-XX-D



Ambassador
MW-XX-K



Inflection
MW-XX-G



Equinox
MW-XX-R



Oblique
MW-XX-N

Recommended Millwork Masquerade™ profile



Mandalay
4.5" MW-XX-H

2.5" MW-XX-H25
3" MW-XX-H3
6" MW-XX-H6



Reveal®
4.25" MW-XX-F

6" MW-XX-F6
8" MW-XX-F8

Recommended Millwork Masquerade profile



Monarch
6" MW-XX-M



Monument®
2.5" MW-XX-S25
4" MW-XX-S4

Color Foundations™ is our commitment to always have representation across 6 key neutral palettes. For our complete color offering, reference color guide in back.

We've identified Color Foundations™ neutrals in the following way: WB (warm beige), CB (cool beige), WG (warm grey), CG (cool grey), B (black), W (white).

Perceptions® Designer Wall Base.

Achieve the look of Millwork® with a cost similar to standard wall base. Perceptions offers more than 150 colors and five standard profiles designed to coordinate with our Millwork Wall Finishing System. So adding architectural flair has never been easier (or more cost-effective).

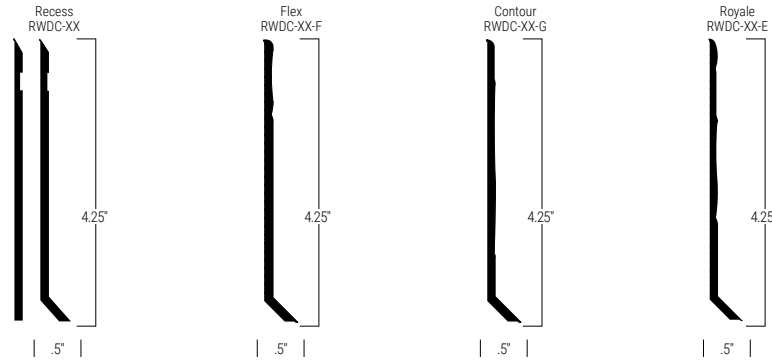

Recess®

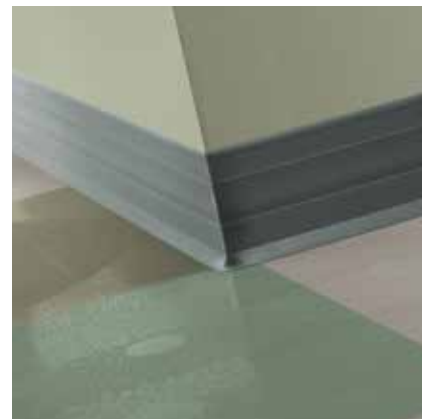

Royale



Flex



Contour

Available in All Standard Colors.



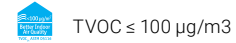
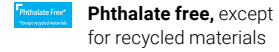
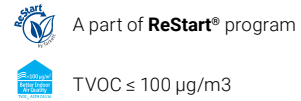

Millwork[®] Masquerade[®]

FINISHING BORDERS

We're printing possibilities.

Our advanced high-definition digital printing technology creates crisp, natural-looking visuals in this unique line of Millwork[®] Wall Finishing Systems—from exotic wood grains to textured stones to intricate abstracts. Choose from 10 standard finishes, or create an entirely customized look without high minimums or long lead times. Digital printing allows us to recreate any digital image flawlessly, and provide exceptional service with quick delivery.

From standard to signature.

The standard Masquerade line offers 10 natural-looking finishes and two profiles: Classic and Reveal. To create a fully customized wall base for your signature design, speak to your Tarkett representative to get started.

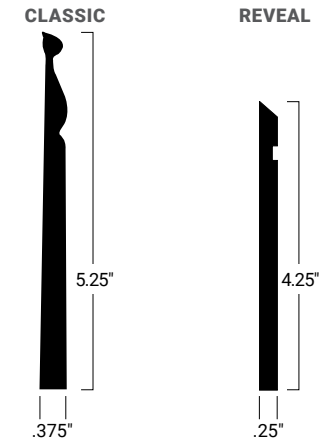

ME3 SEASONED OAK Scout



ME4 SEASONED OAK Falcon



MF4 WHITE OAK Espresso



ME5 SEASONED OAK Peppercorn



MK6 CONCRETE Fallow CB



MK3 METASTONE Ferro



MF6 NATIVE PINE Blanched Grey



MN3 TEXMODE Charcoal B



MM2 TEXGRAIN Charcoal B



ML3 CONCRETE Charcoal B

**Wall Art™ Decorative Wall Base.
Beyond basic.**

With the look of luxurious woods, Wall Art elegantly finishes any space. These high-performance patterns are available in multiple profiles, coordinate easily with your flooring selections, and come with a lower price tag than other wall base options.



REVEAL®



SILHOUETTE®



OUTLINE®



OBLIQUE



SHOE MOULDING



QUARTER ROUND



BWG Balsa



MBE Medium Beech



LOK Light Oak WB



DOK Dark Oak



ACH Amber Cherry



CRW Mission



WAL Walnut



WEN Wenge Wood

**STANDARD
PROFILES**

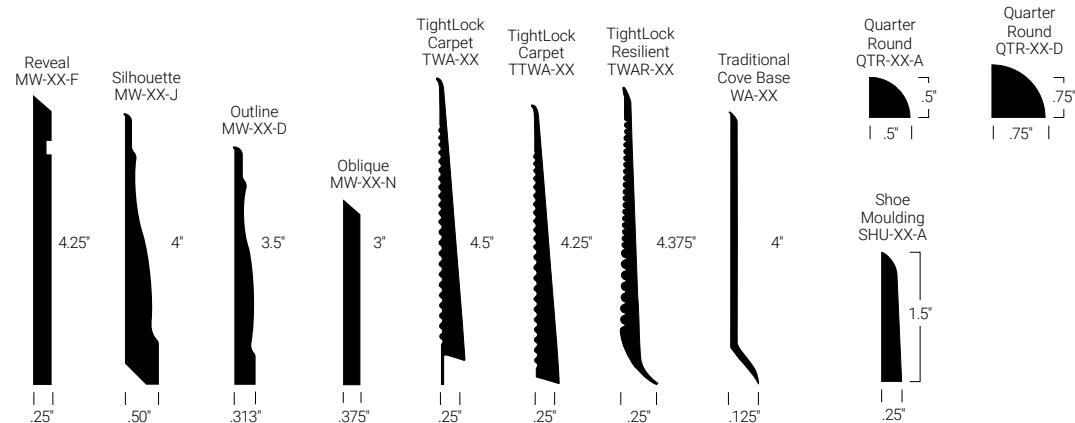

Wall Art™ wood grains available in Millwork® Masquerade® by special request

Traditional Wall Base and TightLock® Wall Base Systems

A part of **ReStart®** program

Phthalate free, except for recycled materials

FloorScore® certified and meets CA 01350*

Recycled Content
Pre-consumer 14%

TVOC ≤ 100 µg/m3

adhesives pg. 196

Traditional Vinyl + Rubber Wall Base.
Keep it simple.

We know there's a time and a place for straightforward, no-nonsense options. That's why our Traditional Wall Base is basic, but better. With durable construction and multiple options for height and color, our Traditional Wall Base has everything you need. And nothing you don't.

TRADITIONAL

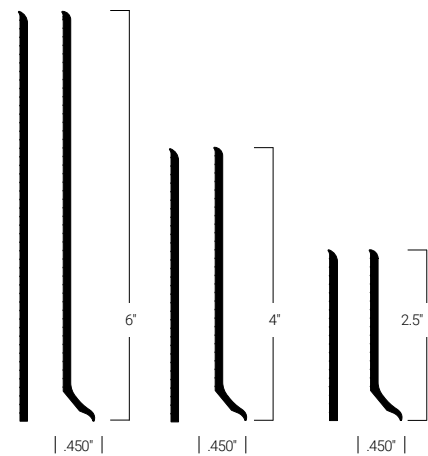

3 standard heights: 2.5" (64 mm), 4" (102 mm), 6" (153 mm) or 4.5" (114 mm) inDC only

Available in Duracove Rubber (type TP)
1/8" (3.175 mm) and vinyl (type TV)
.080" (2 mm) or 1/8" (3.175 mm)

Standard heights available in toe or toeless

4' sections and coils available

Manufactured inside and outside corners available

4.5", 8", 9" and 10" heights are special order; call for details

4.5" in Duracove only

TightLock® Wall Base System. U.S. Patent No. 5,212,923
Lock it up.

When we say TightLock® Carpet Base comes first, it really does. Its notched design allows it to be installed before the carpeting and carpet tile, and remain in place when changing out the flooring too. This saves time and money on re-installation and wall repairs. Plus, this durable, high-performance base can stay in place longer, making it a more sustainable choice. Also available in a Resilient Base, TightLock provides a cove base look with a more subtle radius. With a unique tapered design, the resilient base accommodates any commercial flooring and delivers a tight, clean, finished appearance year after year.

TIGHTLOCK CARPET

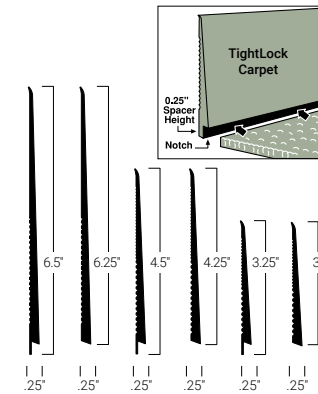

TIGHTLOCK RESILIENT

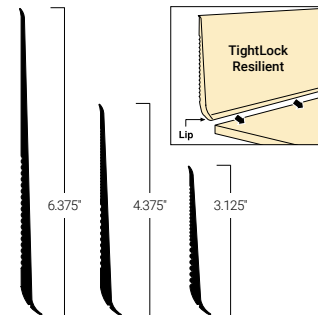

See Color Guide for Availability

4' sections or 75' coils

Manufactured outside corners available

Clean, toeless look

More resistant to damage and distortion from maintenance equipment and chairs

TightLock for carpet
3.25" (83 mm), 3" (76 mm) face
4.5" (114 mm), 4.25" (108 mm) face
6.5" (165 mm), 6.25" (159 mm) face

TightLock for resilient flooring
3.125" (79 mm)
4.375" (111 mm)
6.375" (162 mm)

A part of **ReStart®** program

Cradle to Cradle certified

TVOC ≤ 10 µg/m3

Rapidly Renewable Resources
All profiles 2.3%

3 standard heights: 2.5" (64 mm), 4" (102 mm) or 6" (153 mm)

Standard heights available in toe or toeless

4' sections and coils available

Thermoset rubber (type TS) 1/8" (3.175 mm)

Manufactured inside and outside corners available

BaseWorks® Thermoset Rubber Wall Base.

A natural fusion of aesthetics, performance and sustainability, BaseWorks® rubber wall base delivers pure, uniform color and an attractive matte finish. Its flexibility makes installation quick, easy and inexpensive. Plus, it won't fade, crack or separate from the wall.

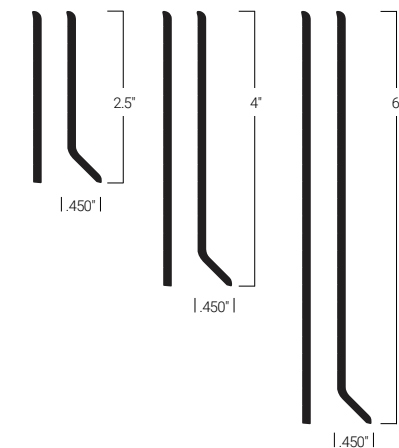

color palette availability
See Color Guide for Availability
*Not available in metallic colors

Tarkett Wall Bases. Tie it together.

The connecting space between wall and floor presents an opportunity to add color, pattern, clean lines, lasting protection—or all of the above. With the most comprehensive collection of wall borders in the country, we make it easy to unify your space with the perfect finishing touch.

	TV Thermoplastic Vinyl*	TP Thermoplastic Rubber	TS Thermoset Rubber*
Phthalate Free	✓	✓	✓
Bio-Based Content			✓
100% Recyclable	✓	✓	✓
10%+ Recycled Content	✓	✓	
Material Assessment Cradle to Cradle Certified™ V.3 Silver			✓
ColorMatch®	✓	✓	✓
No Dye Lots	✓	✓	✓

*Not available in Metallics



Finishing Accessories

The project isn't complete until every seam is flawlessly concealed. Let us help you cross that finish line.

186
Floor Finishing Accessories

189
Wheeled Traffic
Transitions

191
Flexible Corner Guards
Edge Guards
Feature Strips
Tub Mouldings

188
T-Mouldings and Track
Reducers
Adaptors
Slim Line Transitions

190
Thresholds
Cove Filler Strips
Cove Caps

192
SubFloor Leveler System®
193 Tarkolay Underlayment
SureStart™ Underlayment





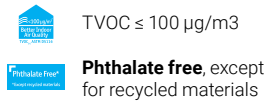
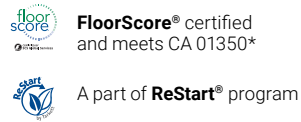

Recycled Content
Pre-consumer 14%
adhesives pg. 196



Floor Finishing

ACCESSORIES

Move right along.

No one has time for road-blocks. That's why our wide range of smooth, safe and seamless Floor Finishing Accessories helps you easily transition from one flooring to another with fewer trips and stumbles.



We've identified Color Foundations neutrals in the following way: **WB** (warm beige), **CB** (cool beige), **WG** (warm grey), **CG** (cool grey), **B** (black), **W** (white).

ColorMatch:
For available colors, reference ColorMatch, in color guide.

Floor Finishing Accessories.

Tarkett's broad selection of transition accessories helps you glide through a space without interference. Find each of your surface thicknesses in the rows and columns below, then trace down and

across to see where they meet in the middle. There, you'll find the solutions that will help you transition from one surface to another. Smooth. Safe. Seamless.

TRANSITION SELECTOR CHART BY DIMENSION									
For profile drawing and details, see specific accessory categories on pages 196-199.									
Gauge	Subfloor	1/16"	.080"	1/8"	3/16"	1/4"	5/16"	3/8"	1/2"
Subfloor		SSR-XX-B	RRS-XX-B SSR-XX-B SLT-XX-J SLTC-XX-J	SSR-XX-B RRS-XX-C SLT-XX-J SLTC-XX-J	EG-XX-J EG-XX-K	CRS-XX-A EG-XX-H CTA-XX-J CTA-XX-JL SLT-XX-L SLTC-XX-L	EG-XX-G EG-XX-L	CRS-XX-B EG-XX-W CTA-XX-P CTA-XX-PL	CRS-XX-D CTA-XX-Q
1/16"	SSR-XX-B						CTA-XX-D		
.080"	RRS-XX-B SSR-XX-B SLT-XX-J SLTC-XX-J		CTA-XX-Y	SLT-XX-B SLTC-XX-B CTA-XX-X SSR-XX-D		SLT-XX-C SLTC-XX-C CTA-XX-HT SLT-XX-H SLTC-XX-H	CTA-XX-D	CTA-XX-Z	
1/8"	SSR-XX-B RRS-XX-C RRS-XX-D SLT-XX-J SLTC-XX-J		SLT-XX-B SLTC-XX-B CTA-XX-X SSR-XX-D	CTA-XX-N FS-XX-DW3		SLT-XX-A SLTC-XX-A CTA-XX-H CTA-XX-HL CTA-XX-A CTA-XX-C CE-XX-A	CTA-XX-D CE-XX-A	CTA-XX-K	CD-XX-B
3/16"	EG-XX-J EG-XX-K								
1/4"	CRS-XX-A EG-XX-H CTA-XX-J CTA-XX-JL SLT-XX-L SLTC-XX-L		SLT-XX-C SLTC-XX-C CTA-XX-HT SLT-XX-H SLTC-XX-H	SLT-XX-A SLTC-XX-A CTA-XX-H CTA-XX-HL CTA-XX-A CTA-XX-C CE-XX-A		CTA-XX-M CD-XX CD-XX-C CD-XX-W	CD-XX CD-XX-C CD-XX-W	CTA-XX-L SLT-XX-F SLTC-XX-F	CE-XX-C SLTC-XX-G SLTC-XX-G
5/16"	EG-XX-G EG-XX-L	CTA-XX-D	CTA-XX-D	CTA-XX-D CE-XX-A		CD-XX CD-XX-C CD-XX-W	CD-XX CD-XX-C CD-XX-W	CCA-XX	CWA-XX
3/8"	CRS-XX-B EG-XX-W CTA-XX-P CTA-XX-PL		CTA-XX-Z	CTA-XX-K		CTA-XX-L SLT-XX-F SLTC-XX-F	CCA-XX		CE-XX-C
1/2"	CRS-XX-D CTA-XX-Q			CD-XX-B		CE-XX-C SLT-XX-G SLTC-XX-G	CWA-XX	CE-XX-C	CD-XX-A

DIMENSIONS BY COLOR

- Identify thickness of materials to be transitioned.
- Find the corresponding color to match the thicknesses.
- Find your colors together on the chart.



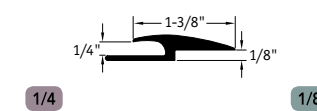

- 0 = 0"
- .080 = .080"
- 3/16 = 3/16"
- 5/16 = 5/16"
- 1/2 = 1/2"
- 1/16 = 1/16"
- 1/8 = 1/8"
- 1/4 = 1/4"
- 3/8 = 3/8"

Example: 1/4" 1/4 material to 1/8" 1/8 material.

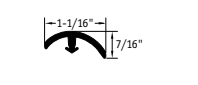
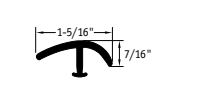
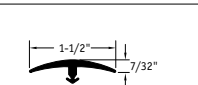
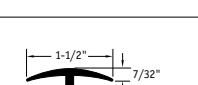
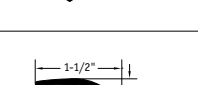
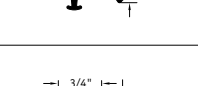
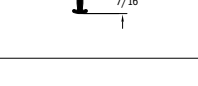

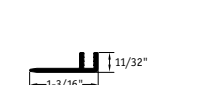
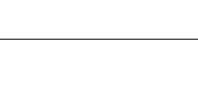

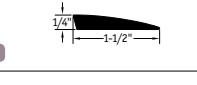
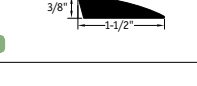
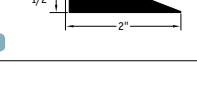
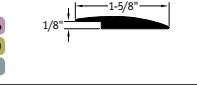
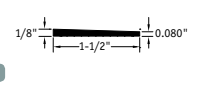
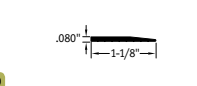
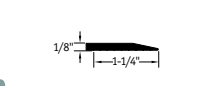
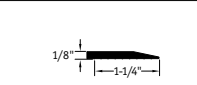

Can't find a transition to meet your needs? Call your Tarkett representative and ask about getting a custom floor finishing accessory made for you. New accessories are added periodically, please visit tarkettna.com for the latest additions.

T-MOULDINGS	
CE-XX-A 1/4" and 5/16" to 1/8" material. 1/4" leg.	
CE-XX-C 1/2" to 1/4" and 3/8" material. 1/2" leg.	
CD-XX 1/4" and 5/16" to material of same height. 1/4" leg.	
CD-XX-A 1/2" to material of same height. 1/2" leg.	
CD-XX-B* 1/2" to 1/8" material. 1/2" leg.	
CD-XX-C 1/4" and 5/16" to material of same height. 1/4" leg.	
CD-XX-W 1/4" and 5/16" to material of same height. 1/4" leg.	

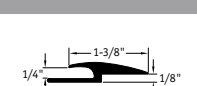
TRACK FOR T-MOULDINGS	
CDB-00-A Rigid Vinyl Pinless for adhesive installations. Neutral color only.	
MT-00-A Aluminum pinless for adhesive installations.	
MTC-00-A Aluminum contour track for adhesive installations. 6' minimum radius.	
MT-00-B Aluminum pin type for stretch-in installations.	
MTC-00-B Aluminum pin type contour track for stretch-in installations. 6' minimum radius.	

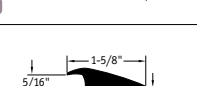
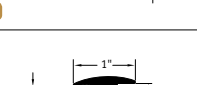
REDUCERS	
CRS-XX-A 1/4" material to floor.	
CRS-XX-B 3/8" material to floor.	
CRS-XX-D 1/2" material to floor.	
SSR-XX-B 35" roll 1/16" or 1/8" material to floor.	
SSR-XX-D 1/8" to .080" material.	
RRS-XX-B 3" pieces .080" material to floor.	
RRS-XX-C 3" pieces 1/8" material to floor.	
RRS-XX-D 25" roll 1/8" material to floor.	

ADAPTORS	
CTA-XX-A 1/4" to 1/8" material.	
CTA-XX-C 1/4" to 1/8" material.	
CTA-XX-D 5/16" to 1/16" or 1/8" material.	
CCA-XX 5/16" to 3/8" material.	
CWA-XX 5/16" to 1/2" material.	

ColorMatch:
For available colors, reference ColorMatch, located in the Color Guide.

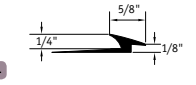
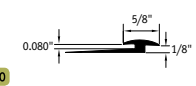
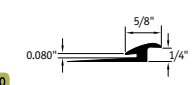
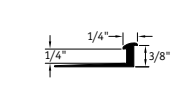
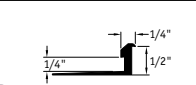
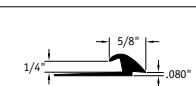
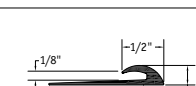
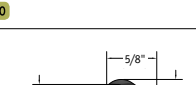





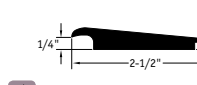

SLIM LINE TRANSITIONS	
SLT-XX-A SLTC-XX-A* 1/4" to 1/8" material.	
SLT-XX-B SLTC-XX-B* .080" to 1/8" material.	
SLT-XX-C SLTC-XX-C* .080" to 1/4" material.	
SLT-XX-F SLTC-XX-F* 1/4" to 3/8" material.	
SLT-XX-G SLTC-XX-G* 1/4" to 1/2" material.	
SLT-XX-H* SLTC-XX-H*† 1/4" to .080" material.	
SLT-XX-J SLTC-XX-J* .080" or 1/8" material to subfloor.	
SLT-XX-L* SLTC-XX-L*† 1/4" material to subfloor.	

*Slim line transitions available for materials with a contour edge. Contour image is for demonstration purposes only and is not to scale.

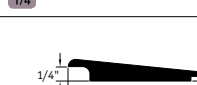
*Slim line transitions also available in metallic colors. See Color Guide for Availability.
†Non ADA Compliant

We've identified Color Foundations neutrals in the following way: **WB** (warm beige), **CB** (cool beige), **WG** (warm grey), **CG** (cool grey), **B** (black), **W** (white).

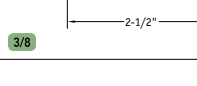
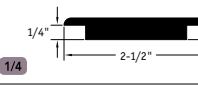
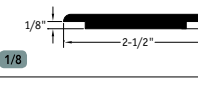
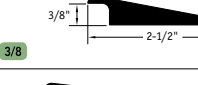
ColorMatch:
For available colors, reference ColorMatch, in color guide.

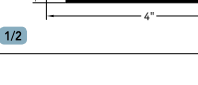
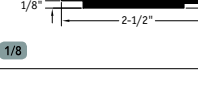
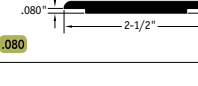
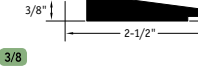
WHEELED TRAFFIC TRANSITIONS	
CTA-XX-H 1/4" to 1/8" material.	
CTA-XX-HL 1/4" to 1/8" material.	
CTA-XX-HT 1/4" to .080" or 2 mm material.	
CTA-XX-J 1/4" material to subfloor.	
CTA-XX-JL 1/4" material to subfloor.	
CTA-XX-K 3/8" to 1/8" material.	
CTA-XX-L 3/8" to 1/4" material.	
CTA-XX-M 1/4" to 1/4" material.	
CTA-XX-N 1/8" to 1/8" material.	
CTA-XX-P 3/8" material to subfloor.	
CTA-XX-PL 3/8" material to subfloor.	
CTA-XX-Q 1/2" material to subfloor.	
CTA-XX-X 1/8" to .080" material.	
CTA-XX-Y .080" to .080" material.	
CTA-XX-Z 3/8" to .080" material.	

†Non ADA Compliant

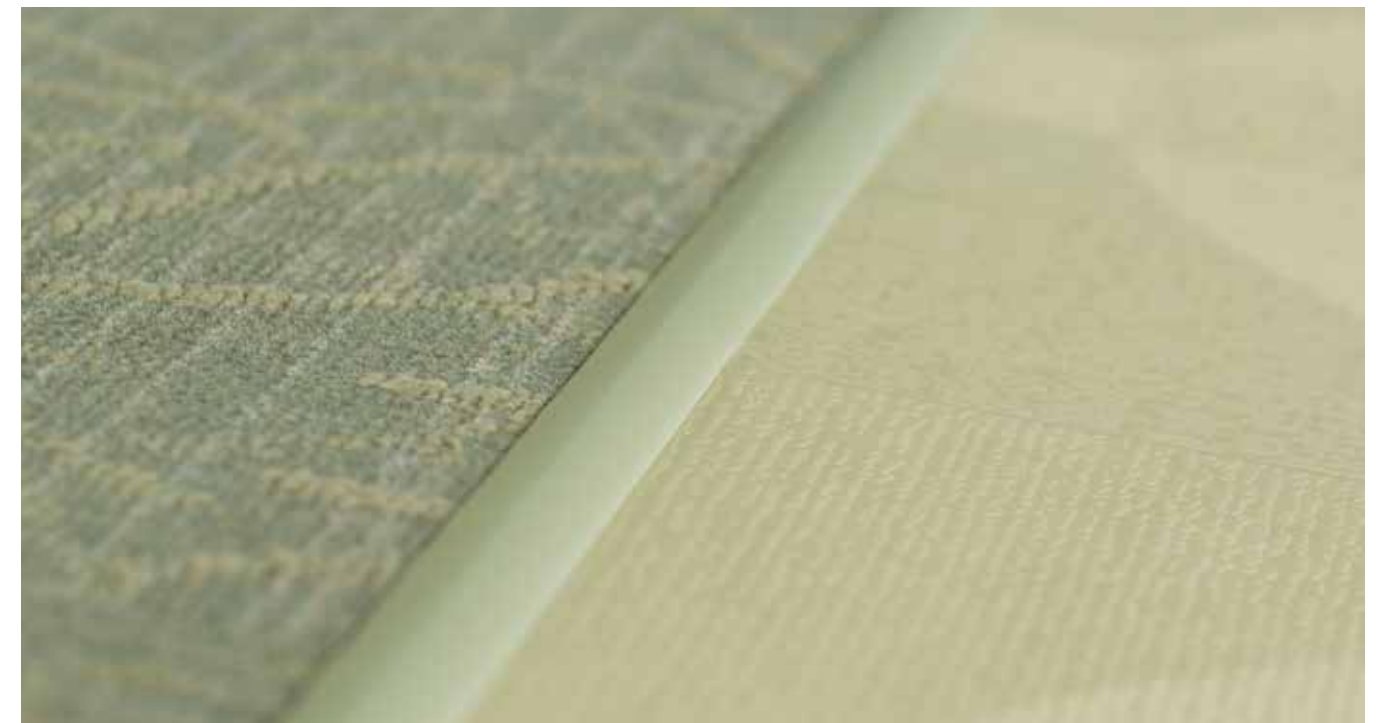

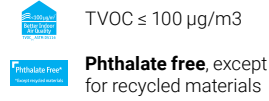
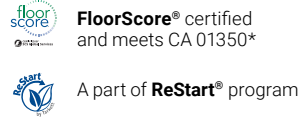

Recycled Content
Pre-consumer 14%
adhesives pg. 196

We've identified Color Foundations neutrals in the following way: **WB** (warm beige), **CB** (cool beige), **WG** (warm grey), **CG** (cool grey), **B** (black), **W** (white).

ColorMatch:
For available colors, reference ColorMatch, in color guide.

THRESHOLDS

<p>VT-XX-M2 3' pieces 5-1/2" exposed surface threshold for stretch-in or adhered carpet and ceramic.</p>	
<p>VT-XX-M6 3' pieces 1-3/4" exposed surface threshold for stretch-in or adhered carpet and ceramic.</p>	

COVE CAPS

<p>SCC-XX-A** For 1/8" materials. 1/8</p>	<p>CCC-XX-B 9/32" inside dimension. 9/32</p>
<p>SCC-XX-B** For 1/8" materials. 1/8</p>	<p>CCC-XX-C** For 1/4" materials. 1/4</p>
<p>CCC-XX-A** For 1/4" or 5/16" materials. 1/4</p>	<p>SCC-XX-D with self-stick tape For .080" materials. 1/4</p>

**Also available in metallic colors. See color guide for availability.

COVE FILLER STRIPS

<p>CFS-00 1-3/4" radius.</p>	
<p>CFS-00-A 1-1/4" radius.</p>	
<p>CFS-00-M 5' pieces .5" radius.</p>	

Due to the use of pre-consumer recycled content, color of cove filler strips will vary.

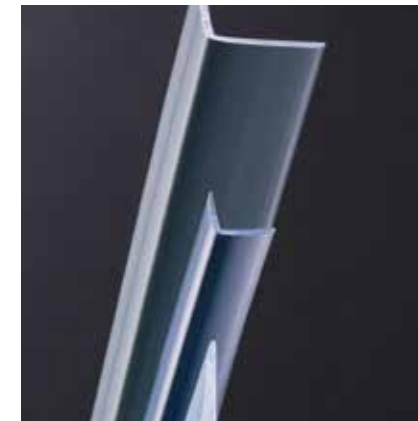

FLEXIBLE CORNER GUARDS

Tarkett's corner guards will not only complement the interior space, but also work to protect your finished design.

- Will not shrink, crack or chip
- Four return sizes: 2-3/8", 1-1/2", 3/4" and 1-1/4"

See Color Guide for availability

FLEXIBLE VINYL CORNER GUARDS

<p>VBG-XX-B-48 VBG-XX-B-96 4' or 8' pieces Corner guard. 3/4" returns. 1/8" thick. Tapered ends.</p>	<p>VBG-XX-A-48 VBG-XX-A-96 4' or 8' pieces Corner guard. 1-1/2" returns. 1/8" thick. Tapered ends.</p>	<p>VBG-XX-48 VBG-XX-96 4' or 8' pieces Corner guard. 2-3/8" returns. 1/8" thick. Tapered ends.</p>	<p>VBG-XX-C 8' pieces Millwork® profile corner guard. 1-1/4" returns. 1/4" thick. See ColorGuide for availability.</p>
--------------------------------------------------------------------------------------------------------------------------------------------	----------------------------------------------------------------------------------------------------------------------------------------------	------------------------------------------------------------------------------------------------------------------------------------------	---------------------------------------------------------------------------------------------------------------------------------------------------

EDGE GUARDS

<p>EG-XX-G 5/16" material to floor. 5/16</p>	
<p>EG-XX-H 1/4" material to floor. 1/4</p>	
<p>EG-XX-J 3/16" material to floor. 3/16</p>	
<p>EG-XX-K† 3/16" material to floor. 3/16</p>	
<p>EG-XX-L† 5/16" material to floor. 5/16</p>	
<p>EG-XX-W† 3/8" material to floor. 3/8</p>	

FEATURE STRIPS

<p>FS-XX-DW3 50' roll 1" wide feature strip for 1/8" material. 1/8</p>	
-------------------------------------------------------------------------------------------	--

TUB MOULDINGS

<p>TM-50* 5' pieces (self-stick) Luster finish cove for bathtub, counter and shelves. 1-1/2" height.</p>	
<p>TM-50-A* 5' pieces (self-stick) Luster finish cove for bathtub, counter and shelves. 1" height.</p>	

*Available in 50 White W only.
†Non ADA Compliant

SUBFLOOR LEVELER SYSTEM® COMPONENTS (BLACK ONLY)	
<p>LS-40-F 4' pieces Reduces 1/8" to 0"</p>	
<p>LS-40 4' pieces Reduces 1/4" to 0". Can be cut at score line to reduce height as indicated.</p>	
<p>LS-40-K 4' pieces Reduces 1/4" to 0". Leveled edge for tack strip installation.</p>	
<p>LS-40-D 4' pieces Reduces 3/8" to 0". Can be cut at score line to reduce height as indicated.</p>	
<p>LS-40-E 4' pieces Reduces 1/2" to 0". Can be cut at score line to reduce height as indicated.</p>	
<p>LS-40-G 4' pieces Reduces 3/4" to 0"</p>	
<p>LS-40-B 4' pieces Reduces 3/8" to 1/4". Can be used alone or with LS-40 to extend transition.</p>	
<p>LS-40-C 4' pieces Reduces 1/2" to 3/8". Can be used alone or with LS-40-D or LS-40-B to extend transition.</p>	

*The LS-40, LS-40-D and LS-40-E Leveler System Components can be cut at specially premarked scoring lines to create lower transitions for 1/8", 3/16", 1/4" or 3/8" gauge heights if needed, or can be cut to create job-specific heights. All SubFloor Leveler System® Components are 4' long or can be special ordered in other lengths.

SubFloor Leveler System®. U.S. Patent No. 7,174,682
Quick Fix.

We've practically eliminated the need for traditional floor levelers—and the labor and curing time they require. Our patented SubFloor Leveler System® provides a gradual ramp between different flooring elevations, creating a smooth transition and fewer trips and falls. With easy installation and the ability to lay flooring immediately over top, it keeps everything moving swiftly—from your project to your foot traffic.

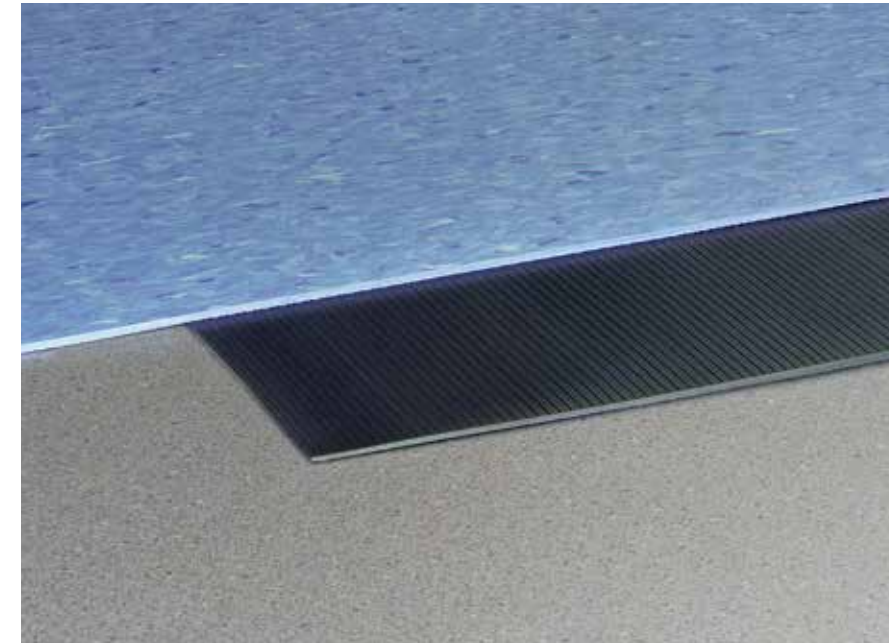

Tarkolay Underlayment.
Breathe easy.

Say goodbye to subpar subfloors. Tarkolay is a thin underlayment that installs immediately over areas where moisture, abatement or other problems exist—protecting the flooring and the indoor air quality. Tarkolay can resist moisture levels as high as 96% RH and provides a natural ventilation between flooring and subfloor. So the floor breathes easier, along with the people working, playing, living and learning within the space.

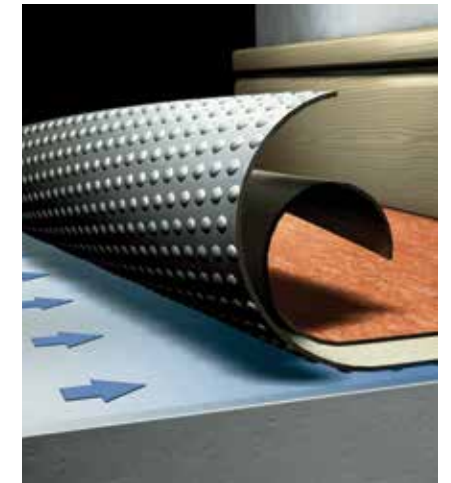

SureStart® Acoustic Underlayment
Quiet is beautiful.

This cutting-edge underlayment for resilient flooring solves a variety of installation issues for almost any subfloor, whether it's on, above or below grade. Made of high-density synthetic rubber, SureStart provides superior moisture mitigation from concrete slabs, delivers unmatched support under interlocking vinyl flooring, and improves acoustics. By absorbing the sound of foot traffic, SureStart dramatically reduces noise levels in both the room where it's installed, and the floor below—making it an ideal choice for a variety of commercial settings. With easy installation and the ability to conceal minor surface imperfections, SureStart is sure to save significant time and labor costs on your next project.





References

We realize the details can make or break a project timeline. From having the right adhesives to knowing the ins and outs of your warranty coverage, get all the answers you need, in one convenient location.

196

Adhesives

201

Color Guide

198

Warranty

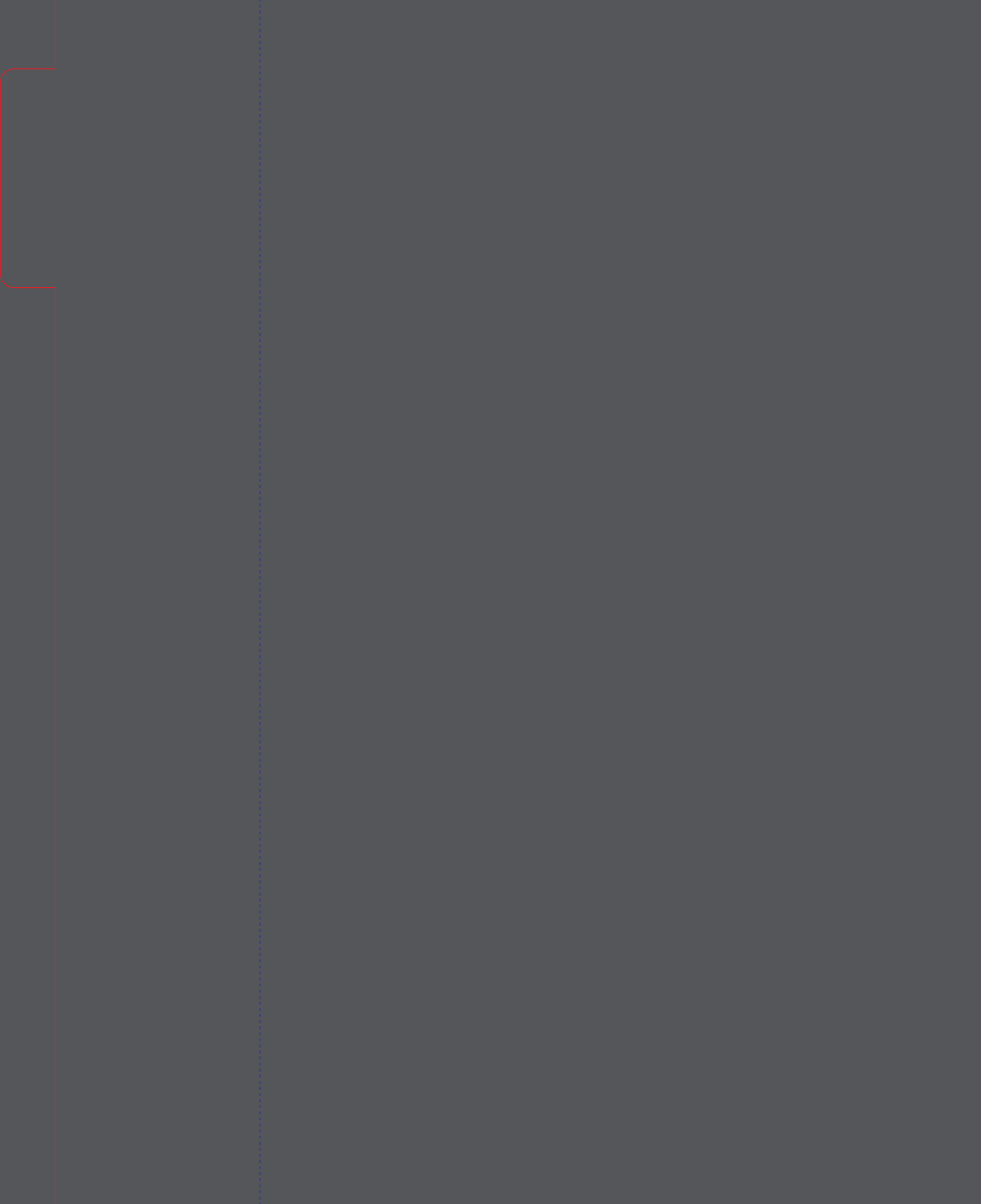

RECOMMENDED
ADHESIVE
APPLICATION
CHART

CWL Cold Weld Liquid
100 Clear Thin Spread Adhesive
RollSmart
901 SpraySmart Resilient Flooring Spray Adhesive
905 Releasable Adhesive
906 Conductive Adhesive
925 Resilient Flooring Adhesive
926 Vinyl Flooring Adhesive
930 Epoxy Caulking Adhesive
946 Premium Compound
950 Linoleum Adhesive
959 Vinyl Tile and Plank Adhesive
960 Wall Base Adhesive
965 Flooring and Tread Adhesive
975 Two-Part Urethane Adhesive
986 Terra-Turf Adhesive
996 Two-Part Epoxy Adhesive
C-TR Adhesives
No Adhesives

Adhesives	CWL	100	RollSmart	901	905	906	925	926	930	946	950	959	960	965	975	986	996	C-TR	No Adhesives
Acczent	X		X	X			X							X					
Acczent Wood Acoustiflor				X			X							X					
Acczent Wood Safe-T			X	X			X							X					
Aria Sheet	X		X	X			X							X					
Aria Tile								X						X					
Tarkett VCT		X		X										X					
Tarkett VCT Basketball Kits		X		X										X					
Azterra				X								X		X					
BaseWorks Thermoset Rubber Wall Base										X			X						
Circulinity							X						X	X			X		
Clean Path Entrance Modular Tile																		X	
Color Essence				X								X		X					
Color Essence SR				X								X		X					
Contract Plus Sheet	X													X					
Contract Plus Tile																			
CorkTones														X	X		X		
Corner Guards - Vinyl										X									
Cortina Grande				X								X		X					
Cortina Grande SR				X								X		X					
Defiant Tile							X							X	X		X		
Defiant Tread							X		X	X				X	X		X		
Eco-Naturals														X	X		X		
Eco-Shell with Cork														X	X		X		
Feature Strips VCT		X													X				
Feature Strips - Vinyl							X	X						X	X		X		
iQ Granit Acoustiflor								X						X					
iQ Granit Sheet	X		X	X			X							X					
iQ Granit Tile								X						X					
iQ Granit SD Sheet	X					X	X							X					
iQ Granit SD Tile						X													
Granit Safe-T			X	X			X							X					
Harmonium xf ² Sheet										X				X					
I.D. Freedom - Luxury Tiles and Planks			X									X		X					
I.D. Inspiration 70 and 55 - Luxury Tile			X									X		X					
Inertia					X1		X							X	X		X		
Interlocking Tiles																			X
Karim Shapes and Kolors				X								X							
Marbled Safe-T			X				X	X						X					
Melodia Sheet	X		X	X			X					X		X					

RECOMMENDED
ADHESIVE
APPLICATION
CHART

CWL Cold Weld Liquid
100 Clear Thin Spread Adhesive
RollSmart
901 SpraySmart Resilient Flooring Spray Adhesive
905 Releasable Adhesive
906 Conductive Adhesive
925 Resilient Flooring Adhesive
926 Vinyl Flooring Adhesive
930 Epoxy Caulking Adhesive
946 Premium Compound
950 Linoleum Adhesive
959 Vinyl Tile and Plank Adhesive
960 Wall Base Adhesive
965 Flooring and Tread Adhesive
975 Two-Part Urethane Adhesive
986 Terra-Turf Adhesive
996 Two-Part Epoxy Adhesive
C-TR Adhesives
No Adhesives

Adhesives	CWL	100	RollSmart	901	905	906	925	926	930	946	950	959	960	965	975	986	996	C-TR	No Adhesives
Melodia 2.0 Tile								X							X				
Mesto Configurations				X										X	X			X	
Metallurgy														X	X			X	
MicroTone Speckled Rubber Tile				X										X	X			X	
Millwork Chair Rail														X					
Millwork Wall Base														X			X		
Millwork Masquerade														X			X		
Minerality Rubber Tiles and Planks				X										X	X			X	
Mouldings - Vinyl														X	X			X	
iQ Natural Sheet	X		X	X			X							X					
iQ Optima Sheet	X		X	X			X							X					
iQ Optima Tile								X						X					
iQ Optima Acoustiflor				X										X					
Perceptions Wall Base														X			X		
Prima Marbleized								X1						X	X			X	
Prima Olio								X1						X	X			X	
Replay Sheet				X										X	X				
Replay Tile														X	X				
Resilient Wall Base														X			X		
Risers-Rubber														X					
Risers- Vinyl														X					
Rubber Floor Tile								X1						X	X			X	
SlideLock Tile																			X
Space Modular Tile														X					
Standard Plus Sheet	X											X							
Standard Plus Tile														X					
Stair Nosings - Vinyl														X	X			X	
Stair Treads - Rubber														X	X			X	
Stair Treads - Vinyl														X	X			X	
Stringers - Rubber														X					
Stringers - Vinyl														X					
SubFloor Leveler System														X					
Tactile Warning Strips														X	X			X	
Tarkolay																			X
Terra-Turf																X			
TightLock Wall Base														X			X		
iQ Toro SC Sheet	X											X	X	X				X	
iQ Toro SC Tile												X							
Training												X	X					X	
Triumph												X1						X	X
UnderLock Tile																			X
Veneto Acoustiflor																	X		
Vent Cove Wall Base														X			X		

Note: This chart is only a guide. Please refer to the product installation instructions or contact Tarkett for specific adhesive recommendations. For the most current adhesive information please visit tarketta.com.
Note: x1 only recommended for releasable applications.

TARKETT WARRANTY OVERVIEW

Tarkett is pleased to offer the world's most- integrated, high-performance flooring system, bringing together design, function and life-safety, leading to enhanced productivity in high-performance environments. All Tarkett products are warranted against manufacturers' defects to ensure high standards of quality, performance and aesthetics.

Limited Warranty Information**Section 1: Compression Molded Rubber Tile**

Limited 5-Year Commercial Warranty for Manufacturing Defects: Tarkett warrants from the date of purchase for a period of five (5) years of Commercial use that molded rubber tile flooring products conform to written specifications and are free of manufacturing defects, subject to the terms and conditions specified herein.

The customer must notify Tarkett of any obvious visual defects prior to installation; otherwise this warranty will not apply. If the defect is found and Tarkett is notified in writing prior to installation, Tarkett will replace any defective product, at no charge. If the customer believes the product to be defective after installation, the customer must promptly notify Tarkett and permit an inspection of the product. If, upon inspection, Tarkett determines that the product is defective, Tarkett will replace or repair the defective product at its own cost, subject to the limitations in this warranty, and prorated as follows: Material and 100% Reasonable Labor Costs (Year 1); Material and 50% Reasonable Labor Costs (Year 2); and Material Only (Years 3-5).

Tarkett warrants that the products will not wear through for the warranty period of five (5) years of Commercial use. For claims based on wear-through, the customer must notify Tarkett and permit an inspection of the flooring. If Tarkett determines that the original flooring is worn through, Tarkett will replace or repair the worn flooring at its own cost; however, labor costs will be the customer's responsibility except as provided on the prorated basis described in the prior paragraph.

Section 2: Rubber or Vinyl Stair Treads

Limited 5-Year Commercial Warranty for Manufacturing Defects: Tarkett warrants from the date of purchase for a period of five (5) years of Commercial use that rubber or vinyl stair tread products conform to written specifications and are free of manufacturing defects, subject to the terms and conditions specified herein.

The customer must notify Tarkett of any obvious visual defects prior to installation; otherwise this warranty will not apply. If the defect is found and Tarkett is notified in writing prior to installation, Tarkett will replace any defective product, at no charge. If the customer believes the product to be defective after installation, the customer must promptly notify Tarkett and permit an inspection of the product. If, upon inspection, Tarkett determines that the product is defective, Tarkett will replace or repair the defective product at its own cost, subject to the limitations in this warranty, and prorated as follows: Material and 100% Reasonable Labor Costs (Year 1); Material and 50% Reasonable Labor Costs (Year 2); and Material Only (Years 3-5).

Section 3: Finishing Borders (Wall Base and Accessories)

Limited 2-Year Commercial Warranty for Manufacturing Defects: Tarkett warrants from the date of purchase for a period of two (2) years of Commercial use that rubber or vinyl wall base and/or accessory products conform to written specifications and are free of manufacturing defects, subject to the terms and conditions specified herein.

The customer must notify Tarkett of any obvious visual defects prior to installation; otherwise this warranty will not apply. If the defect is found and Tarkett is notified in writing prior to installation, Tarkett will replace any defective product, at no charge. If the customer believes the product to be defective after installation, the customer must promptly notify Tarkett and permit an inspection of the product. If, upon inspection, Tarkett determines that the product is defective, Tarkett will replace or repair the defective product at its own cost, subject to the limitations in this warranty, and prorated as follows: Material and 100% Reasonable Labor Costs (Year 1); Material and 50% Reasonable Labor Costs (Year 2).

Section 4: Vinyl Sheet and Tile Flooring

Limited 10-Year Commercial Warranty for Manufacturing Defects: Tarkett warrants from the date of purchase for a period of ten (10) years of Commercial use that vinyl sheet and tile flooring products conform to written specifications and are free of manufacturing defects, subject to the terms and conditions specified herein.

The customer must notify Tarkett of any obvious visual defects prior to installation; otherwise this warranty will not apply. If the defect is found and Tarkett is notified in writing prior to installation, Tarkett will replace any defective product, at no charge. If the customer believes the product to be defective after installation, the customer must promptly

SECTION	PRODUCT TYPE	TARKETT BRAND PRODUCT LINES
1	Compression Molded Rubber Tile	Circulinity™; CorkTones™; Defiant™; Eco-Shell™ with Cork; Folio™; MicroTone™; Mesto Configurations™; Metallurgy™; Minerality™;Prima® Olio® and Marbleized; Replay® Tiles; Safe Sense™ Solid Color Rubber Tile; Tactile Walking Surface Indicators; Terra-Turf®; Triumph and Inertia™
2	Rubber or Vinyl Stair Treads	Safe Sense™ Tactile Warning Surface; Safe-T-First®
3	Finishing Borders (Wall Base) Finishing Accessories	BaseWorks™; Masquerade™; Millwork®; Perceptions™; TightLock®; Wall Art™; Traditional Millwork®; Masquerade®; Wall Art™; BaseWorks®; Traditional; Perceptions®; TightLock®; rePLACE®; Finishing Accessories
4	Vinyl Sheet and Tile Flooring	Acczent®; Acczent® Flourish; Acczent® Wood Acoustiflor®; Acczent® Wood Safe-T; Aria™ 2.0; iQ™ Granit™/ iQ™ Granit™ Micro; iQ™ Granit™ SD; iQ™ Natural; iQ™ Optima®; iQ™ Optima® Acoustiflor®; iQ™ Toro SC; Granit™ Safe-T; Marbled Safe-T; Melodia™ 2.0; Standard Plus; Training®
5	Vinyl Composition Tile and Plank	A: Vinyl Composition Tile (VCT): Azrock® ; Azrock® TexTile™ B: Vinyl Enhanced Tile (VET): Azterra™ ; Color Essence™ Solid Vinyl Tile (SVT): Cortina Grande™ ; GemStone™
6	Linoleum Sheet Flooring	Harmonium xf2™; Veneto Acoustiflor®
7	Luxury Tile and Plank	A: I.D. Freedom™; Transcend™ SureSet™ ; I.D. Inspiration™ 55 B: I.D. Inspiration™ 70
8	Luxury Tile and Plank (Light Commercial)	A: Aloft™ Click; Aloft™ Glue Down B: Transcend™ Click
9	Underlayment	SureStart™ Underlayment; Tarkolay Underlayment

notify Tarkett and permit an inspection of the product. If, upon inspection, Tarkett determines that the product is defective, Tarkett will replace or repair the defective product at its own cost, subject to the limitations in this warranty, and prorated as follows: Material and 100% Reasonable Labor Costs (Year 1); Material and 50% Reasonable Labor Costs (Year 2); and Material Only (Years 3-10).

Tarkett warrants that the products will not wear through for the warranty period of ten (10) years of Commercial use. For claims based on wear-through, the customer must notify Tarkett and permit an inspection of the flooring. If Tarkett determines that the original flooring is worn through, Tarkett will replace or repair the worn flooring at its own cost; however, labor costs will be the customer's responsibility except as provided on the prorated basis described in the prior paragraph.

Section 5A: Vinyl Composition Tile and Plank

Limited 10-Year Commercial Warranty for Manufacturing Defects: Tarkett warrants from the date of purchase for a period of ten (10) years of Commercial use that vinyl composition tile and plank flooring products conform to written specifications and are free of manufacturing defects, subject to the terms and conditions specified herein.

The customer must notify Tarkett of any obvious visual defects prior to installation; otherwise this warranty will not apply. If the defect is found and Tarkett is notified in writing prior to installation, Tarkett will replace any defective product, at no charge. If the customer believes the product to be defective after installation, the customer must promptly notify Tarkett and permit an inspection of the product. If, upon inspection, Tarkett determines that the product is defective, Tarkett will replace or repair the defective product at its own cost, subject to the limitations in this warranty, and prorated as follows: Material and 100% Reasonable Labor Costs (Year 1); Material and 50% Reasonable Labor Costs (Year 2); and Material Only (Years 3-10).

Tarkett warrants that the products will not wear through for the warranty period of ten (10) years of Commercial use. For claims based on wear-through, the customer must notify Tarkett and permit an inspection of the flooring. If Tarkett determines that the original flooring is worn through, Tarkett will replace or repair the worn flooring at its own cost; however, labor costs will be the customer's responsibility except as provided on the prorated basis described in the prior paragraph.

Section 5B: Vinyl Tile Flooring

Limited 10-Year Commercial Warranty for Manufacturing Defects: Tarkett warrants from the date of purchase for a period of ten (10) years of Commercial use that vinyl tile flooring products conform to written specifications and are free of manufacturing defects, subject to the terms and conditions specified herein.

The customer must notify Tarkett of any obvious visual defects prior to installation; otherwise this warranty will not apply. If the defect is found and Tarkett is notified in

writing prior to installation, Tarkett will replace any defective product, at no charge. If the customer believes the product to be defective after installation, the customer must promptly notify Tarkett and permit an inspection of the product. If, upon inspection, Tarkett determines that the product is defective, Tarkett will replace or repair the defective product at its own cost, subject to the limitations in this warranty, and prorated as follows: Material and 100% Reasonable Labor Costs (Year 1); Material and 50% Reasonable Labor Costs (Year 2); and Material Only (Years 3-10).

Tarkett warrants that the products will not wear through for the warranty period of ten (10) years of Commercial use. For claims based on wear-through, the customer must notify Tarkett and permit an inspection of the flooring. If Tarkett determines that the original flooring is worn through, Tarkett will replace or repair the worn flooring at its own cost; however, labor costs will be the customer's responsibility except as provided on the prorated basis described in the prior paragraph.

Section 6: Linoleum Sheet Flooring

Limited 5-Year Commercial Warranty for Manufacturing Defects: Tarkett warrants from the date of purchase for a period of five (5) years of Commercial use that linoleum sheet flooring products conform to written specifications and are free of manufacturing defects, subject to the terms and conditions specified herein.

The customer must notify Tarkett of any obvious visual defects prior to installation; otherwise this warranty will not apply. If the defect is found and Tarkett is notified in writing prior to installation, Tarkett will replace any defective product, at no charge. If the customer believes the product to be defective after installation, the customer must promptly notify Tarkett and permit an inspection of the product. If, upon inspection, Tarkett determines that the product is defective, Tarkett will replace or repair the defective product at its own cost, subject to the limitations in this warranty, and prorated as follows: Material and 100% Reasonable Labor Costs (Year 1); Material and 50% Reasonable Labor Costs (Year 2); and Material Only (Years 3-5).

Tarkett warrants that the products will not wear through for the warranty period of five (5) years of Commercial use. For claims based on wear-through, the customer must notify Tarkett and permit an inspection of the flooring. If Tarkett determines that the original flooring is worn through, Tarkett will replace or repair the worn flooring at its own cost; however, labor costs will be the customer's responsibility except as provided on the prorated basis described in the prior paragraph.

Section 7A: Luxury Tiles and Plank

Limited 10-Year Commercial Warranty for Manufacturing Defects: Tarkett warrants from the date of purchase for a period of ten (10) years of Commercial use that luxury tile and plank flooring products conform to written specifications and are free of manufacturing defects, subject to the terms and conditions specified herein.

The customer must notify Tarkett of any obvious visual defects prior to installation; otherwise this warranty will not apply. If the defect is found and Tarkett is notified in writing prior to installation, Tarkett will replace any defective product, at no charge. If the customer believes the product to be defective after installation, the customer must promptly notify Tarkett and permit an inspection of the product. If, upon inspection, Tarkett determines that the product is defective, Tarkett will replace or repair the defective product at its own cost, subject to the limitations in this warranty, and prorated as follows: Material and 100% Reasonable Labor Costs (Year 1); Material and 50% Reasonable Labor Costs (Year 2); and Material Only (Years 3-10).

Tarkett warrants that the products will not wear through for the warranty period of five (5) years of Commercial use. For claims based on wear-through, the customer must notify Tarkett and permit an inspection of the flooring. If Tarkett determines that the original flooring is worn through, Tarkett will replace or repair the worn flooring at its own cost; however, labor costs will be the customer's responsibility except as provided on the prorated basis described in the prior paragraph.

Section 7B: Luxury Tiles and Plank

Limited 20-Year Commercial Warranty for Manufacturing Defects: Tarkett warrants from the date of purchase for a period of twenty (20) years of Commercial use that luxury tile and plank flooring products conform to written specifications and are free of manufacturing defects, subject to the terms and conditions specified herein.

The customer must notify Tarkett of any obvious visual defects prior to installation; otherwise this warranty will not apply. If the defect is found and Tarkett is notified in writing prior to installation, Tarkett will replace any defective product, at no charge. If the customer believes the product to be defective after installation, the customer must promptly notify Tarkett and permit an inspection of the product. If, upon inspection, Tarkett determines that the product is defective, Tarkett will replace or repair the defective product at its own cost, subject to the limitations in this warranty, and prorated as follows: Material and 100% Reasonable Labor Costs (Year 1); Material and 50% Reasonable Labor Costs (Year 2); Material Only (Years 3-10); 50% Material Only (Years 11-15); and 25% Material Only (Years 16-20).

Tarkett warrants that the products will not wear through for the warranty period of five (5) years of Commercial use. For claims based on wear-through, the customer must notify Tarkett and permit an inspection of the flooring. If Tarkett determines that the original flooring is worn through, Tarkett will replace or repair the worn flooring at its own cost; however, labor costs will be the customer's responsibility except as provided on the prorated basis described in the prior paragraph.

Section 8A: Luxury Tiles and Plank (Light Commercial)

Light Commercial Warranty for Manufacturing Defects: Tarkett warrants from the date of purchase for a period of seven (7) years of Light Commercial use that luxury tile and plank flooring products conform to written specifications and are free of manufacturing defects, subject to the terms and conditions specified herein. Light Commercial applications are defined as foot-traffic only (no rolling loads).

The customer must notify Tarkett of any obvious visual defects prior to installation; otherwise this warranty will not apply. If the defect is found and Tarkett is notified in writing prior to installation, Tarkett will replace any defective product, at no charge. If the customer believes the product to be defective after installation, the customer must promptly notify Tarkett and permit an inspection of the product. If, upon inspection, Tarkett determines that the product is defective, Tarkett will replace or repair the defective product at its own cost, subject to the limitations in this warranty, and prorated as follows: Material and 100% Reasonable Labor Costs (Year 1); Material and 50% Reasonable Labor Costs (Year 2); Material Only (Years 3-5); and 50% Material Only (Years 6-7).

Tarkett warrants that the products will not wear through for the warranty period of seven (7) years of Light Commercial use. For claims based on wear-through, the customer must notify Tarkett and permit an inspection of the flooring. If Tarkett determines that the original flooring is worn through, Tarkett will replace or repair the worn flooring at its own cost; however, labor costs will be the customer's responsibility except as provided on the prorated basis described in the prior paragraph.

Section 8B: Luxury Tiles and Plank (Light Commercial)

Light Commercial Warranty for Manufacturing Defects: Tarkett warrants from the date of purchase for a period of ten (10) years of Light Commercial use that luxury tile and plank flooring products conform to written specifications and are free of manufacturing defects, subject to the terms and conditions specified herein. Light Commercial applications

are defined as foot-traffic only (no rolling loads).

The customer must notify Tarkett of any obvious visual defects prior to installation; otherwise this warranty will not apply. If the defect is found and Tarkett is notified in writing prior to installation, Tarkett will replace any defective product, at no charge. If the customer believes the product to be defective after installation, the customer must promptly notify Tarkett and permit an inspection of the product. If, upon inspection, Tarkett determines that the product is defective, Tarkett will replace or repair the defective product at its own cost, subject to the limitations in this warranty, and prorated as follows: Material and 100% Reasonable Labor Costs (Year 1); Material and 50% Reasonable Labor Costs (Year 2); Material Only (Years 3-5); and 50% Material Only (Years 6-10).

Tarkett warrants that the products will not wear through for the warranty period of ten (10) years of Light Commercial use. For claims based on wear-through, the customer must notify Tarkett and permit an inspection of the flooring. If Tarkett determines that the original flooring is worn through, Tarkett will replace or repair the worn flooring at its own cost; however, labor costs will be the customer's responsibility except as provided on the prorated basis described in the prior paragraph.

Section 9: Underlayment

Limited 10-Year Light Commercial Warranty for Manufacturing Defects: Tarkett warrants from the date of purchase for a period of ten (10) years of Light Commercial use of SureStart™ underlayment with approved Tarkett LVT products, subject to subfloors being prepared & meeting Tarkett Installation Instruction guidelines and subject to the terms and conditions specified herein.

The customer must notify Tarkett of any obvious visual defects or concerns prior to install; otherwise this warranty will not apply.

If the defect is found and Tarkett is notified in writing prior to installation, Tarkett will replace any defective product, at no charge. If the customer believes the product to be defective after installation, the customer must promptly notify Tarkett and permit an inspection of the product. If, upon inspection, Tarkett determines that the product is defective, Tarkett will replace or repair the defective product at its own cost, subject to the limitations in this warranty, and prorated as follows: Material and 100% Reasonable Labor Costs (Year 1); Material and 50% Reasonable Labor Costs (Year 2); and Material Only (Years 3-10).

All Tarkett Commercial Products:

This Limited Warranty applies only for products installed, used and maintained according to the written recommendations and specifications provided by at the time of material purchase.

Warranty Claim Procedure

To be eligible for replacement under this warranty, the customer must file a claim by giving Tarkett written notice of the defect. This notice must be filed immediately, but in no event more than 10 days following discovery of the defect. Notice shall be given to Tarkett at its corporate address of 30000 Aurora Road, Solon, Ohio 44139. Phone: (800) 899-8916; Fax: (440) 543-5774.

If defective product has been discontinued or is otherwise unavailable, Tarkett reserves the right to select and supply the customer with Tarkett replacement flooring, similar in quality and quantity to the material claimed to be defective.

Warranty Exclusions

The Tarkett Limited Warranty does not apply to:

- The exact matching of shade, color or mottling
- Any promise made by any salesperson or representative, unless such promise is express and made in a written form
- Tears, burns, cuts or damage due to improper installation or use or improper cleaning agents and maintenance methods
- Labor costs outside of prorated schedule defined in the warranty
- Sales of non-first quality materials, i.e., "seconds," "off goods" or other irregular flooring. Such non-first quality materials are sold "as is."
- Issues associated with the use of adhesives other than those recommended by Tarkett
- Issues caused by moisture or alkali in the subfloor. Pre-installation moisture and alkali testing is required and must be made available to Tarkett upon request.
- Subfloor contamination or markings that bleed through the flooring material causing discoloration or staining
- Problems caused by installation, uses and maintenance that are contrary to Tarkett's specifications, recommendations or instructions

- Material installed with obvious defects not notified to Tarkett prior to installation
- Exterior installations – Tarkett products are designed for interior applications only
- Fading and/or discoloration resulting from heavy sunlight penetration and ultraviolet ray exposure from direct or glass-filtered sunlight
- Damage to flooring products caused by high or spiked heels, improper protectors/casters or furniture rests. Some rolling-type casters on furniture or appliances may damage resilient flooring. Warranty as to the suitability of the factory-installed casters rests with the furniture or appliance manufacturers. Casters must be suitable for use on resilient flooring to avoid warranty exclusions.
- Damage to flooring products from pallet jack and tow-motor traffic
- Premature wear or deterioration from spikes and skate blade exposure
- Variations in color or embossing between products, photography or printed color illustrations
- Installation of Tarkett flooring in work or commercial areas exposed to oil and grease, such as commercial kitchens or butcher shops. Defiant Oil and Grease-Resistant Rubber tiles are recommended in such situations.
- Additional expense associated with overtime, replacing or moving appliances or furniture, business interruptions, loss of use or other related costs associated with the replacement of the flooring

Warranty Disclaimer

Tarkett MAKES NO WARRANTIES WHATSOEVER, EXPRESS OR IMPLIED WITH RESPECT THERETO, INCLUDING WARRANTIES OF MERCHANTABILITY OR FITNESS FOR A PARTICULAR PURPOSE.

These warranties are in lieu of any other warranty expressed or implied. Tarkett shall not be liable for any incidental or consequential damages which may result from a defect or whether based on breach of express or implied warranty, negligence, strict liability or any other legal theory, except where the exclusion or limitation of incidental or consequential damages is prohibited by state law. These warranties provide specific legal rights; these and other rights may vary from state to state. To learn the legal rights in a specific state, consult the local or state Consumer Affairs Office or the State Attorney General.

All of the above is for reference only – for the latest product-specific information regarding warranties, installation and maintenance, please visit tarkettna.com.

MICROTONE™ SPECKLED RUBBER TILE thickness = 1/8" (3.2 mm), .080" (2 mm) as seen on pages 37-39

LA1 Peanut Brittle • Field: 286 Fortune Cookie; Speckles: 21 Platinum, 09 Clay, 22 Pearl
 LA2 Wedgewood • Field: 465 Seafarer; Speckles: 32 Pebble 38 Pewter, 24 Grey Haze
 LA3 Seaspray • Field: 27 Mist; Speckles: 21 Platinum, 09 Clay, 194 Antique White
 LA4 Hudson Valley • Field: 601 Asparagus; Speckles: 48 Grey, 608 Mountain Laurel, 34 Almond
 LA5 Chesapeake Bay • Field: 291 Laguna; Speckles: 71 Storm Cloud, 50 White, 21 Platinum
 LA6 Antique Ivory • Field: 27 Mist; Speckles: 38 Pewter, 09 Clay, 08 Icicle
 LA7 Dark Roast • Field: 284 Ganache; Speckles: 33 Adobe Peach, 55 Silver Grey, 49 Beige
 LA8 Banana Republic • Field: 604 Rubber Ducky; Speckles: 71 Storm Cloud, 01 Snow White, 38 Pewter
 LA9 Ceramic Glaze • Field: 09 Clay; Speckles: 40 Black, 29 Moon Rock, 50 White
 LB1 Vanilla Bean • Field: 47 Brown; Speckles: 29 Moon Rock, 45 Sandalwood, 09 Clay
 LB2 Great Plains • Field: 49 Beige; Speckles: 32 Pebble, 22 Pearl, 50 White
 LB3 Sepia Tone • Field: 11 Canvas; Speckles: 50 White, 28 Medium Grey, 80 Fawn
 LB4 Mottled Egg • Field: 24 Grey Haze; Speckles: 29 Moon Rock, 55 Silver Grey, 50 White
 LB5 Nightfall • Field: 92 Blue Lagoon; Speckles: 40 Black, 71 Storm Cloud, 38 Pewter
 LB6 Quenched • Field: 84 Blue Jeans; Speckles: 30 Ink, 144 Blueprint, 139 Glacier
 LB7 Go Blue • Field: 70 Bluest; Speckles: 470 Cerulean, 106 Skinny Dip, 50 White
 LB8 Vortex • Field: 40 Black; Speckles: 48 Grey, 38 Pewter, 21 Platinum
 LB9 Rainstorm • Field: 20 Charcoal; Speckles: 40 Black, 28 Medium Grey, 21 Platinum
 LC1 Smokiness • Field: 71 Storm Cloud; Speckles: 40 Black, 28 Medium Grey, 21 Platinum
 LC2 City Block • Field: 28 Medium Grey; Speckles: 71 Storm Cloud, 38 Pewter, 21 Platinum
 LC3 The Times • Field: 21 Platinum; Speckles: 40 Black, 48 Grey, 50 White
 LC4 Mountaineer • Field: 48 Grey; Speckles: 40 Black, 55 Silver Grey, 50 White
 LC5 Riverbed • Field: 32 Pebble; Speckles: 63 Burnt Umber, 29 Moon Rock, 12 Hard Rock
 LC6 Nightowl • Field: 55 Silver Grey; Speckles: 71 Storm Cloud, 28 Medium Grey, 50 White
 LC7 Best Seller • Field: 23 Vapor Grey; Speckles: 71 Storm Cloud, 28 Medium Grey, 50 White
 LC8 Melody • Field: 468 Gulfstream; Speckles: 28 Medium Grey, 38 Pewter, 50 White
 LC9 Dino • Field: 608 Mountain Laurel; Speckles: 190 Greege, 289 Jaded, 27 Mist
 LD1 Rainshower • Field: 591 Sleet; Speckles: 28 Medium Grey,

38 Pewter, 460 Cotton
 LD2 Backwoods • Field: 41 Sea Breeze; Speckles: 86 Hunter Green, 622 Silver Thyme, 24 Grey Haze
 LD3 Indigo Dye • Field: 18 Navy Blue; Speckles: 71 Storm Cloud, 32 Pebble, 24 Grey Haze
 LD4 Rain Puddle • Field: 58 Windsor Blue; Speckles: 18 Navy Blue, 590 Denim, 38 Pewter
 LD5 Williamsburg • Field: 38 Pewter; Speckles: 28 Medium Grey, 24 Grey Haze, 34 Almond
 LD6 Cosmology • Field: 63 Burnt Umber; Speckles: 29 Moon Rock, 49 Beige, 32 Pebble
 LD7 Lunar Explorer • Field: 29 Moon Rock; Speckles: 63 Burnt Umber, 55 Silver Grey, 24 Grey Haze
 LD8 Crumbcake • Field: 130 Sisal; Speckles: 80 Fawn, 19 Desert Camel, 34 Almond
 LD9 Peacock Plume • Field: 609 Cozumel; Speckles: 72 Harbour, 27 Mist, 590 Denim
 LE2 Chocolate Cream • Field: 45 Sandalwood; Speckles: 47 Brown, 09 Clay, 22 Pearl
 LE3 Silkworm • Field: 129 Silk; Speckles: 32 Pebble, 130 Sisal, 194 Antique White
 LE4 Log Cabin • Field: 80 Fawn; Speckles: 48 Grey, 49 Beige, 12 Hard Rock
 LE5 El Giza • Field: 22 Pearl; Speckles: 29 Moon Rock, 05 Stone, 195 Antique White
 LE6 Emerald City • Field: 471 Bok Choy; Speckles: 135 Chinese Jade, 21 Platinum, 460 Cotton
 LE7 Cameleon • Field: 138 Celery; Speckles: 55 Silver Grey, 130 Sisal, 01 Snow White
 LE8 French Toast • Field: 136 Beachy; Speckles: 121 Cement, 286 Fortune Cookie, 01 Snow White
 LE9 Tropical Smoothie • Field: 473 Butterscotch; Speckles: 644 Inca Trail, 76 Cinnamon, 194 Antique White
 LF1 Cape May • Field: 79 Bone White; Speckles: 80 Fawn, 09 Clay, 08 Icicle
 LF2 Wedding Cake • Field: 01 Snow White; Speckles: 80 Fawn, 09 Clay, 21 Platinum
 LF3 Dragonwyck • Field: 621 Tupelo; Speckles: 665 Sawgrass, 150 Wetlands, 01 Snow White
 LF4 Cedar Grove • Field: 622 Silver Thyme; Speckles: 29 Moon Rock, 21 Platinum, 01 Snow White
 LF5 Irish Meadow • Field: 467 Arugula; Speckles: 135 Chinese Jade, 21 Platinum, 01 Snow White
 LF6 Sherwood Forest • Field: 135 Chinese Jade; Speckles: 38 Pewter, 22 Pearl, 01 Snow White
 LF7 Blueberry Pie • Field: 630 Blue Chip; Speckles: 18 Navy Blue, 55 Silver Grey, 21 Platinum
 LF8 High Seas • Field: 470 Cerulean; Speckles: 92 Blue Lagoon, 465 Seafarer, 08 Icicle
 LF9 Caribbean Cruise • Field: 631 Montego Bay; Speckles: 58 Windsor Blue, 21 Platinum, 50 White
 LG1 Freshaire • Field: 590 Denim; Speckles: 71 Storm Cloud, 21 Platinum, 08 Icicle
 LG2 Wizardry • Field: 162 Sovereign; Speckles: 40 Black,

137 Veiled Violet, 121 Cement
 LG3 Grape Tart • Field: 472 Imperial; Speckles: 92 Blue Lagoon, 21 Platinum, 08 Icicle
 LG4 Crunchbar • Field: 42 Sable; Speckles: 76 Cinnamon, 33 Adobe Peach, 12 Hard Rock
 LG5 Georgian Clay • Field: 287 Rustic; Speckles: 76 Cinnamon, 55 Silver Grey, 09 Clay
 LG6 Wine Cellar • Field: 85 Burgundy; Speckles: 48 Grey, 38 Pewter, 55 Silver Grey
 LG7 Mystique • Field: 469 Mystify; Speckles: 38 Pewter, 12 Hard Rock, 01 Snow White
 LG8 Tuscan Olive • Field: 190 Greege; Speckles: 20 Charcoal, 09 Clay, 27 Mist
 LG9 Unfettered • Field: 474 Zen; Speckles: 135 Chinese Jade, 130 Sisal, 27 Mist
 LH1 Herbal Remedy • Field: 632 Cilantro; Speckles: 86 Hunter Green, 608 Mountain Laurel, 27 Mist
 LH2 Savannah • Field: 475 Marshland; Speckles: 474 Zen, 138 Celery, 01 Snow White
 LH3 Harmony • Field: 476 Parkway; Speckles: 28 Medium Grey, 24 Grey Haze, 01 Snow White
 LH4 Penny Arcade • Field: 644 Inca Trail; Speckles: 29 Moon Rock, 09 Clay, 22 Pearl
 LH5 Red River Valley • Field: 646 Mesquite; Speckles: 38 Pewter, 09 Clay, 22 Pearl
 LH6 Coffee Bean • Field: 76 Cinnamon; Speckles: 121 Cement, 24 Grey Haze, 12 Hard Rock
 LH7 Sizzling • Field: 664 Tarjaj; Speckles: 23 Vapor Grey, 32 Pebble, 469 Mystify
 LH8 Toscana • Field: 665 Sawgrass; Speckles: 48 Grey, 190 Greege, 194 Antique White
 LH9 Alpine • Field: 86 Hunter Green; Speckles: 48 Grey, 38 Pewter, 24 Grey Haze
 LJ1 Glazed Icing • Field: 68 White Sand; Speckles: 21 Platinum, 129 Silk, 79 Bone White
 LJ2 Spring Valley • Field: 593 Duckweed; Speckles: 21 Platinum, 59 Heather Green, 194 Antique White
 LJ3 Reflecting Pool • Field: 667 Nice Teal; Speckles: 21 Platinum, 24 Grey Haze, 27 Mist
 LJ4 Sugar Plum • Field: 670 Clematis; Speckles: 18 Navy Blue, 38 Pewter, 11 Canvas
 LJ5 Glacier Lake • Field: 106 Skinny Dip; Speckles: 40 Black, 192 Tidewater, 24 Grey Haze
 LJ6 Cinnamon Toast • Field: 149 Milk Chocolate; Speckles: 80 Fawn, 130 Sisal, 22 Pearl
 LJ7 Wayne Manor • Field: 24 Grey Haze; Speckles: 28 Medium Grey, 55 Silver Grey, 194 Antique White
 LJ8 Summerset • Field: 677 Sharp Cheddar; Speckles: 09 Clay, 286 Fortune Cookie, 01 Snow White
 LJ9 High Energy • Field: 670 Clematis; Speckles: 38 Pewter, 29 Moon Rock, 31 Zephyr
 LE1 Sandbox • Field: 31 Zephyr; Speckles: 32 Pebble, 27 Mist, 01 Snow White
 LK1 Red Caboose • Field: 163 Salsa; Speckles: 284 Ganache, 28 Medium Grey, 24 Grey Haze

TRIUMPH AND INERTIA MULTI-FUNCTIONAL AND SPORTS FLOORING thickness = 3/8" (9.5 mm) as seen on page 142-143

KJ1 Marino • Field: 18 Navy; Speckles: 467 Arugula, 590 Denim, 58 Windsor Blue
 KJ2 Tidal • Field: 58 Windsor Blue; Speckles: 590 Denim, 18 Navy Blue, 476 Parkway
 KJ3 Brownout • Field: 47 Brown; Speckles: 281 Grizzly, 45 Sandalwood, 199 Dockside
 KJ4 Cocolite • Field: 149 Milk Chocolate; Speckles: 286 Fortune Cookie, 47 Brown, 49 Beige
 KJ5 Browns Town • Field: 63 Burnt Umber; Speckles: 48 Grey, 05 Stone, 38 Pewter
 LB9 Rainstorm • Field: 20 Charcoal; Speckles: 40 Black, 21 Platinum, 28 Medium Grey
 LD7 Lunar Explorer • Field: 29 Moon Rock; Speckles: 63 Burnt Umber, 55 Silver Grey, 24 Grey Haze

KJ6 Grey Area • Field: 38 Pewter; Speckles: 24 Grey Haze, 48 Grey, 21 Platinum
 LB8 Vortex • Field: 40 Black; Speckles: 48 Grey, 38 Pewter, 21 Platinum
 LE4 Log Cabin • Field: 80 Fawn; Speckles: 48 Grey, 49 Beige, 12 Hard Rock
 KJ7 Burged • Field: 85 Burgundy; Speckles: 646 Mesquite, 199 Dockside, 45 Sandalwood
 KJ8 Strong Blue • Field: 70 Bluest; Speckles: 192 Tidewater, 475 Marshland, 38 Pewter
 KJ9 Forestation • Field: 86 Hunter Green; Speckles: 474 Zen, 290 Tea Green, 38 Pewter
 KK3 Tea Leaves • Field: 632 Cilantro; Speckles: 21 Platinum, 86 Hunter Green, 151 Iguana,

KK6 Fortunate • Field: 286 Fortune Cookie; Speckles: 45 Sandalwood, 76 Cinnamon, 129 Silk
 KL2 Passion • Field: TB6 Flame; Speckles: 130 Sisal, 121 Cement, 644 Inca
 KL3 Bright Sun • Field: TB5 Sunspot; Speckles: 460 Cotton, 28 Medium Grey, 55 Silver Grey
 LB2 Great Plains • Field: 49 Beige; Speckles: 32 Pebble, 22 Pearl, 50 White
 LC7 Best Seller • Field: 23 Vapor Grey; Speckles: 28 Medium Grey, 50 White, 71 Storm Cloud
 LB4 Mottled Egg • Field: 24 Grey Haze; Speckles: 29 Moon Rock, 50 White, 55 Silver Grey

DEFIANT OIL AND GREASE RESISTANT RUBBER TILE thickness = 1/8" (3.2 mm) as seen on page 160

277 Cold Front • Field: 48 Grey; Speckles: 38 Pewter, 40 Black
 278 Dress Blues • Field: 18 Navy Blue; Speckles: 38 Pewter, 58 Windsor Blue

279 Dew Point • Field: 86 Hunter Green; Speckles: 59 Heather Green, 49 Beige
 729 Thickett • Field: 80 Fawn; Speckles: 29 Moon Rock, 49 Beige

732 Tundra • Field: 20 Charcoal; Speckles: 38 Pewter, 40 Black
 733 Molten • Field: 40 Black; Speckles: 38 Pewter, 48 Grey

Guide to Color

OUR SYSTEM MAKES IT EASY TO COORDINATE ACROSS FLOORING OPTIONS, FINISHING BORDERS AND ACCESSORIES.

Subtle hues
to bold
statements.

SOLID COLORS

SOLID COLORS

METALLIC COLORS

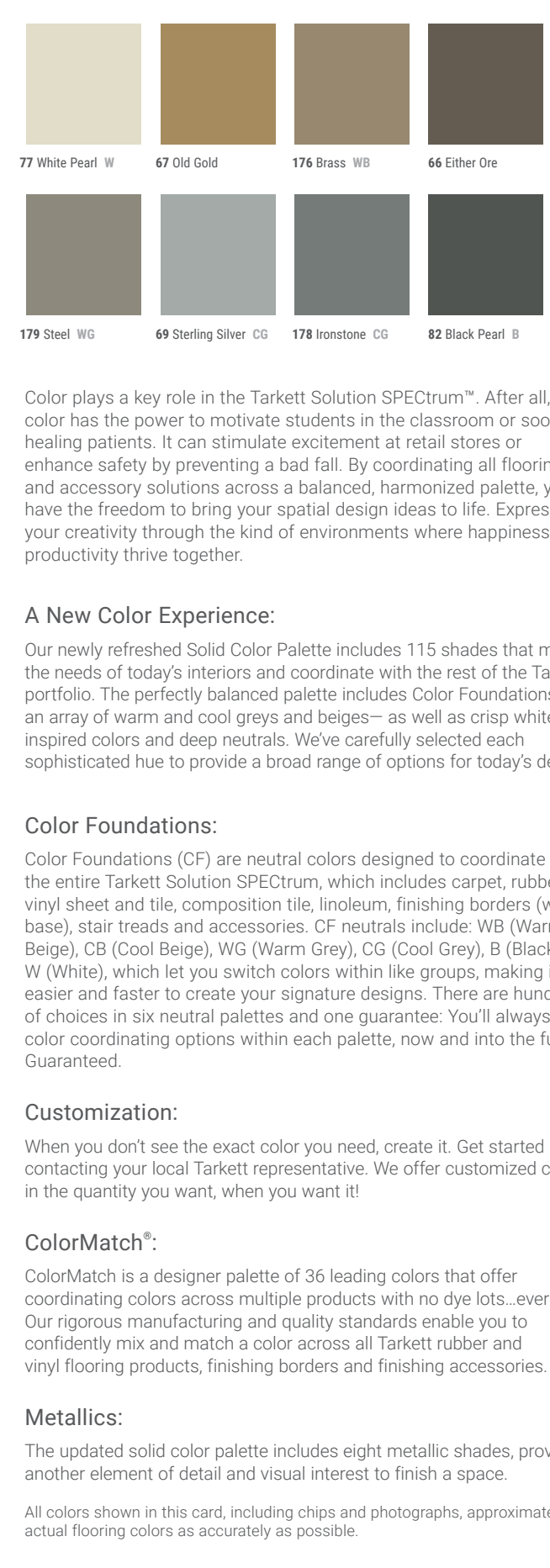
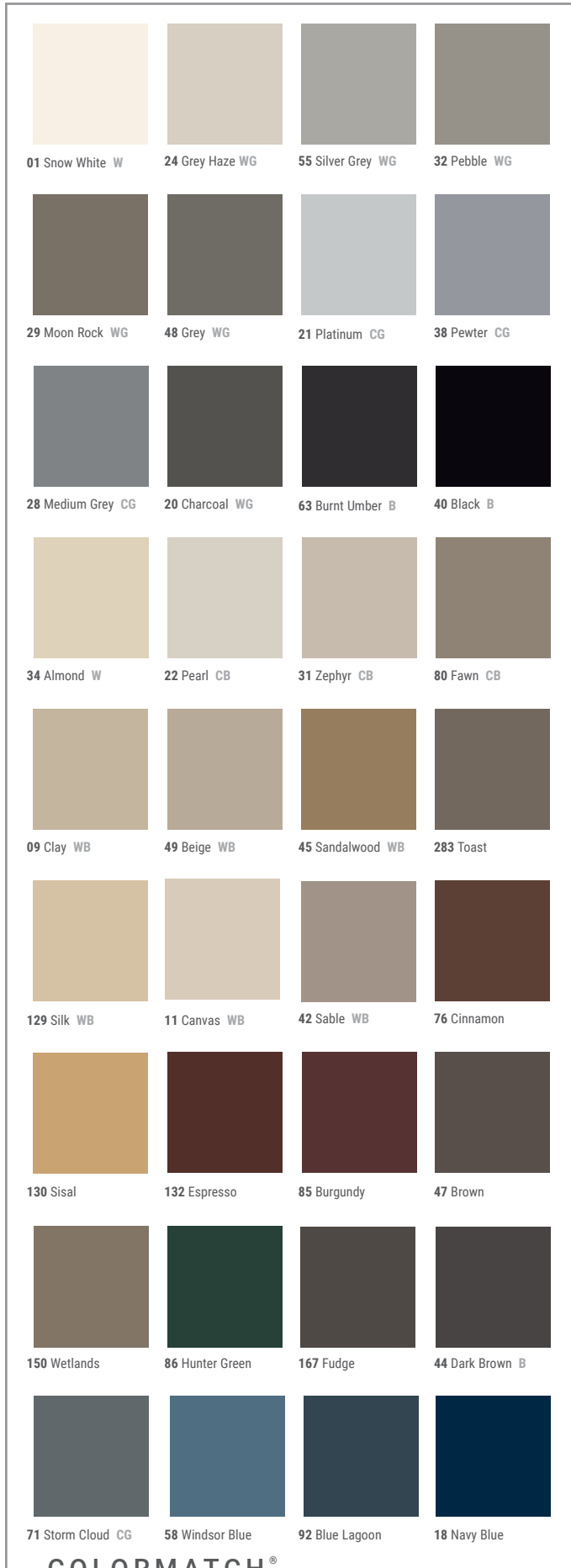

Color plays a key role in the Tarkett Solution SPECTrum™. After all, color has the power to motivate students in the classroom or soothe healing patients. It can stimulate excitement at retail stores or enhance safety by preventing a bad fall. By coordinating all flooring and accessory solutions across a balanced, harmonized palette, you have the freedom to bring your spatial design ideas to life. Express your creativity through the kind of environments where happiness and productivity thrive together.

A New Color Experience:

Our newly refreshed Solid Color Palette includes 115 shades that meet the needs of today's interiors and coordinate with the rest of the Tarkett portfolio. The perfectly balanced palette includes Color Foundations—an array of warm and cool greys and beiges— as well as crisp whites, inspired colors and deep neutrals. We've carefully selected each sophisticated hue to provide a broad range of options for today's designs.

Color Foundations:

Color Foundations (CF) are neutral colors designed to coordinate over the entire Tarkett Solution SPECTrum, which includes carpet, rubber, vinyl sheet and tile, composition tile, linoleum, finishing borders (wall base), stair treads and accessories. CF neutrals include: WB (Warm Beige), CB (Cool Beige), WG (Warm Grey), CG (Cool Grey), B (Black), W (White), which let you switch colors within like groups, making it easier and faster to create your signature designs. There are hundreds of choices in six neutral palettes and one guarantee: You'll always have color coordinating options within each palette, now and into the future. Guaranteed.

Customization:

When you don't see the exact color you need, create it. Get started by contacting your local Tarkett representative. We offer customized colors in the quantity you want, when you want it!

ColorMatch®:

ColorMatch is a designer palette of 36 leading colors that offer coordinating colors across multiple products with no dye lots...ever! Our rigorous manufacturing and quality standards enable you to confidently mix and match a color across all Tarkett rubber and vinyl flooring products, finishing borders and finishing accessories.

Metallics:

The updated solid color palette includes eight metallic shades, providing another element of detail and visual interest to finish a space.

All colors shown in this card, including chips and photographs, approximate the actual flooring colors as accurately as possible.

COLOR AVAILABILITY CHART

Chart indicates standard availability across all traditional Tarkett solutions.

Don't see the color you want in the product you need? Just ask. Put our customization to the test.

COLOR PALETTES					
	TARKETT SOLUTIONS	SOLID COLOR (Including ColorMatch®)	COLORMATCH ONLY	METALLICS	SPECIAL NOTES
WALL BASE SOLUTIONS	Duracove and Rubber Wall Base	●		●	4" Traditional Toe standard in Wall Art.
	Vinyl Wall Base	●			
	Baseworks Thermoset Rubber Wall Base	●			
	Perceptions	●		●	
	TightLock	●		●	4.5" TightLock Carpet, 4.25" TightLock Carpet (w/o Spacer), 4.375" TightLock Resilient standard in Wall Art.
	Millwork (including Chair Rail, Corner Guard and Shoe Moulding)	●		●	
	Millwork Wall Art <i>(including Quarter Round and Shoe Moulding)</i>				Standard in Millwork Profiles Reveal, Silhouette, Outline, and Oblique.
	Millwork Masquerade				Standard in Millwork Profiles Reveal and Classic. Custom Digital Printing.
FLOOR FINISHING ACCESSORIES	Floor Finishing Accessories		●		
	Slim Line Transitions		●	●	
RUBBER FLOORING SOLUTIONS	Rubber Tile <i>(All textures)</i>	●			Prima Marbleized and Prima Olio are special order.
	MicroTone Speckled Rubber Tile in 1/8" and 0.080" Tiles Triumph and Inertia Rubber				Please refer to Tarkett Product Guide or tarkettna.com for the standard Speckled colorway offerings. Or, expand your options by using the color guide to create your own unique speckled pattern.
	Mesto and Mesto Configurations Rubber Tile				Please refer to Tarkett Product Guide for the standard color offerings for Mesto Configurations rubber flooring. Custom colors by special request.
	Metallurgy Rubber Tile				Please refer to Tarkett Product Guide for the standard colorway offerings for Metallurgy rubber flooring.
	Eco-Naturals CorkTones Rubber Tile		●		Custom colors with cork are available by special request.
	Eco-Naturals Eco-Shell with Cork Rubber Tile				Please refer to Tarkett Product Guide for the standard color offerings for Eco-Shell with Cork rubber flooring. Custom colors by special request.
	Defiant Oil & Grease Resistant Rubber Tile				Please refer to Tarkett Product Guide for the standard color offerings for Defiant Oil & Grease Resistant rubber flooring.
STAIRWELL SOLUTIONS	Rubber Stair Treads	●			Some profiles available in Speckled tile colorways as standard. Custom colors, Prima Marbleized and Olio patterns and Mesto colorways by special request.
	Rubber Stringers and Risers	●			
	Vinyl Treads, Stringers, Risers & Nosings		●		
	Slim Line Nosings		●	●	
	Metallurgy Rubber Stair Treads				Please refer to Tarkett Product Guide for the standard colorway offerings for Metallurgy rubber flooring.
<p>How to order: Specify Texture Code below Swatch-Color Number-Gauge. For example, to order Rice Paper in color 49 Beige in 1/8" gauge, specify: FRPA - 49 - 1/8".</p>					

Tarkett North America

30000 Aurora Rd
Solon, OH 44139
800.899.8916

tarkettna.com

29899300032

©2018 Tarkett North America
11/2018



29899900018

TARKETTNA.COM 800.899.8916

